

				
Klasična izvedba kablskih vezic <b>2</b>	Barvne kablске vezice <b>3</b>	Vezice s kovinskim jezičkom odporne na UV svetlobo <b>4</b>	Toplotno odporne kablске vezice <b>4</b>	Vezice PA12 <b>5</b>
				
Odvezljive vezice <b>5</b>	Odvezljiva vezica s kroglicami <b>6</b>	Vezice z napisno ploščico <b>6</b>	Vezica za pritrjevanje na panele <b>7</b>	Vijačni podstavki za vezice, pritržitev z 2 strani <b>7</b>
				
Samolepilni vijačni podstavki za vezice, pritržitev s 4 strani <b>8</b>	Zidni vložki za vezice <b>9</b>	Objemke za kable z žebjem <b>10</b>	Vrstni klipi za pričvrstitev kablov/cevi <b>10</b>	Vrstni pritrjevalci kablov in cevi <b>11</b>
				
Rebrasta sponka za pritrjevanje vodov <b>11</b>	Zidni vložki z robom s kavljem ali kljuko <b>12</b>	Zidni vložki z robom in vijakom s šestkotno glavo s podložko <b>12</b>	Visoko vzdržljiv najlonski zidni vložek za vse vrste materialov <b>13</b>	Vijačni vložek za mavčno dozo <b>13</b>
				
PE vložek <b>14</b>	Zidni vložek, zabijalni +vijak <b>14</b>	Podaljšani vložek <b>14</b>	Vložek z robom <b>15</b>	Samozatezni vložek <b>15</b>
				
Stropni vijaki <b>16</b>	Jekleni vložki za oblikovanje zanke iz jeklene vrvi <b>16</b>	Jekleni kavelj <b>17</b>	Spone »U« jeklene vrvi <b>17</b>	Spone jeklene vrvi, dvojne <b>18</b>
				
Spone jeklene vrvi <b>18</b>	Karabin, vijačni <b>19</b>	Zategovalec <b>20</b>	Zaščitne cevi za kable <b>21</b>	Plastična kablсka mreža <b>21</b>

## Razlaga piktogramov v glavi tabel



Dolžina



Barva

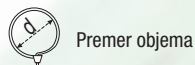

Premer objema

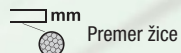

Premer žice



Zidni vložek

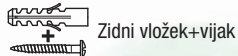

Zidni vložek+vijak

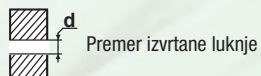

Premer izvrtane luknje



Nosilnost,  
natezna trdnost

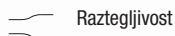

Raztegljivost

## Piktogrami tehničnih podatkov



Material: Poliamid 6.6

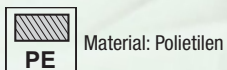

Material: Polietilen



Material: PET

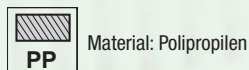

Material: Polipropilen



UV-odpornost



Tališče

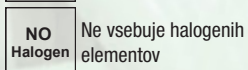

Ne vsebuje halogenih  
elementov

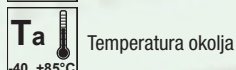

Temperatura okolja



Delovna temperatura

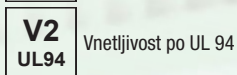

Vnetljivost po UL 94

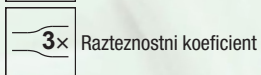

Razteznostni koeficient



Električna prebojna  
trdnost

## Klasična izvedba kabelskih vezic

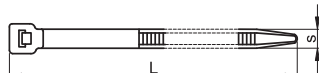

TRACON					
<b>80PR</b>		<b>81PR</b>		75 × 2.2 mm	0.75-15 mm
<b>120PR</b>		<b>121PR</b>		98 × 2.5 mm	1-21 mm
<b>130PR</b>		<b>131PR</b>		135 × 2.6 mm	1-32 mm
<b>150PR</b>		<b>151PR</b>		140 × 3.6 mm	2-36 mm
<b>160PR</b>		<b>161PR</b>		160 × 2.6 mm	1-40 mm
<b>180PR</b>		<b>181PR</b>		180 × 7.8 mm	3.5-45 mm
<b>200PR</b>		<b>201PR</b>		200 × 2.6 mm	1-52 mm
<b>170PR</b>		<b>171PR</b>		200 × 3.6 mm	2-50 mm
<b>190PR</b>		<b>191PR</b>		200 × 4.8 mm	3-50 mm
<b>250PR</b>		<b>251PR</b>		250 × 4.8 mm	3-68 mm
<b>280PR</b>		<b>281PR</b>		280 × 8.0 mm	4-65 mm
<b>230PR</b>		<b>231PR</b>		290 × 3.6 mm	2-80 mm
<b>210PR</b>		<b>211PR</b>		290 × 4.8 mm	3.5-79 mm
<b>300PR</b>		<b>301PR</b>		300 × 7.8 mm	5-80 mm
<b>220PR</b>		<b>221PR</b>		360 × 4.8 mm	3.5-103 mm
<b>260PR</b>		<b>261PR</b>		365 × 7.8 mm	8-100 mm
<b>370PR</b>		<b>371PR</b>		370 × 3.6 mm	5-108 mm
<b>430PR</b>		<b>431PR</b>		430 × 4.8 mm	3.5-115 mm
<b>450PR</b>		<b>451PR</b>		450 × 7.8 mm	35-130 mm
<b>530PR</b>		<b>531PR</b>		550 × 8 mm	10-160 mm
<b>540PR</b>		<b>541PR</b>		540 × 7.8 mm	35-158 mm
<b>760PR</b>		<b>761PR</b>		780 × 9 mm	35-233 mm
<b>850PR</b>		<b>851PR</b>		850 × 12.6 mm	40-255 mm
<b>1000PR</b>		<b>1001PR</b>		1000 × 12.6 mm	40-302 mm



RELEVANT STANDARD  
**EN 62275**



Trajna odpornost na: ogljikovodikove derivate, organska topila, alkohole  
 Omejena odpornost na: organske kisline, baze, anorganske soli, ostale organske materiale  
 Neodpornost na: anorganske kisline in na oksidirajoča sredstva!

**B/14**

**TG008**



**TG007**



**TG010**



## Barvne kabelske vezice

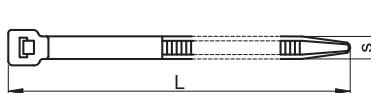
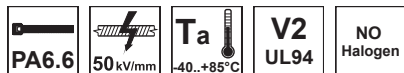

TRACON					
<b>120K</b>		98 × 2.5 mm	1-21 mm	45 N	
<b>150P</b>		140 × 3.6 mm	2-36 mm	80 N	
<b>150Z</b>		140 × 3.6 mm	2-36 mm	80 N	
<b>200K</b>		200 × 2.6 mm	1-52 mm	45 N	
<b>170K</b>		200 × 3.6 mm	2-50 mm	80 N	
<b>170P</b>		200 × 3.6 mm	2-50 mm	80 N	
<b>190K</b>		200 × 4.8 mm	3-50 mm	110 N	
<b>230NZ</b>		290 × 3.6 mm	2-80 mm	80 N	

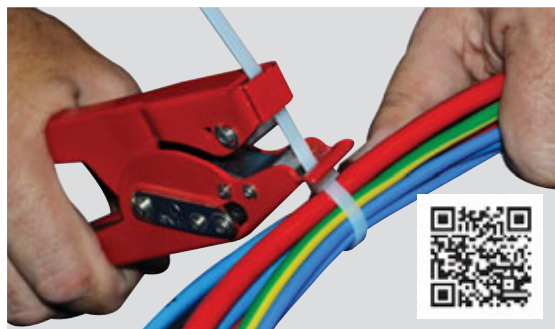

RELEVANT STANDARD  
EN 62275



## Vezice s kovinskim jezičkom

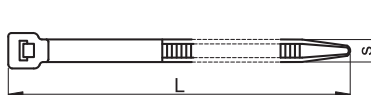
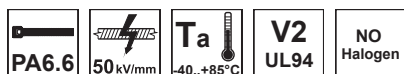

TRACON				
<b>T92</b>		92 × 2.4 mm	2-16 mm	35 N
<b>T140</b>		140 × 3.6 mm	2-29 mm	75 N
<b>T186</b>		186 × 4.8 mm	3.5-45 mm	110 N
<b>T200</b>		200 × 2.4 mm	2-50 mm	35 N
<b>T208</b>		208 × 3.6 mm	2-50 mm	75 N
<b>T281</b>		281 × 3.6 mm	2-76 mm	75 N
<b>T293</b>		293 × 4.8 mm	3.5-78 mm	110 N
<b>T338</b>		338 × 7.6 mm	3.5-120 mm	110 N
<b>T360</b>		360 × 4.8 mm	3.5-102 mm	110 N



## Veziče s kovinskim jezičkom odporne na UV svetlobo

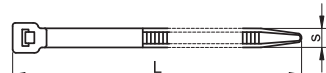

TRACON				
<b>TU92</b>		92 × 2.4 mm	2-16 mm	35 N
<b>TU140</b>		140 × 3.6 mm	2-29 mm	75 N
<b>TU186</b>		186 × 4.8 mm	3.5-45 mm	110 N
<b>TU200</b>		200 × 2.4 mm	2-50 mm	35 N
<b>TU208</b>		208 × 3.6 mm	2-50 mm	75 N
<b>TU281</b>		281 × 3.6 mm	2-76 mm	75 N
<b>TU293</b>		293 × 4.8 mm	3.5-78 mm	110 N
<b>TU338</b>		338 × 7.6 mm	3.5-120 mm	110 N
<b>TU360</b>		360 × 4.8 mm	3.5-102 mm	110 N



## Toplotno odporne kabelske vezice

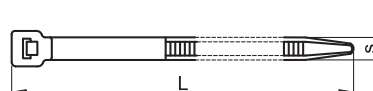

TRACON					
<b>260T</b>		365 × 7.8 mm	8-100 mm	135 °C (5-8 min)	250 N

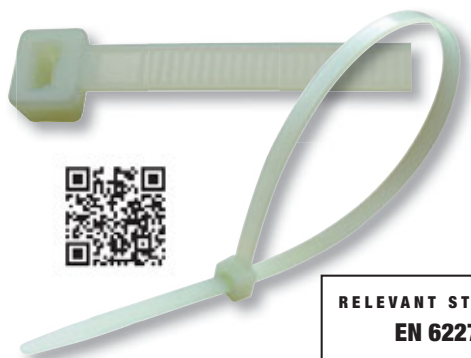

RELEVANT STANDARD  
EN 62275



**PROSIMO, ODČITAJTE KODO!**

- Oglejte si novosti
- Bodite na tekočem

Naša paleta izdelkov se nenehno širi!  
Katalog odraža stanje aprila 2019.  
Za ažurne informacije obiščite  
našo spletno stran!

## Vezice PA12

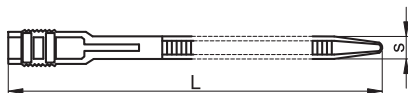
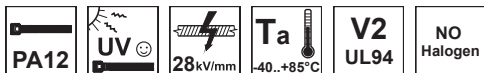

TRACON				
<b>115-12</b>		115 × 6.0 mm	4-25 mm	120 N
<b>132-12</b>		132 × 9.0 mm	4-27 mm	120 N
<b>180-12</b>		180 × 9.0 mm	5-45 mm	150 N
<b>265-12</b>		260 × 9.0 mm	25-65 mm	250 N
<b>300-12</b>		300 × 9.0 mm	25-80 mm	225 N
<b>360-12</b>		350 × 9.0 mm	25-93 mm	250 N

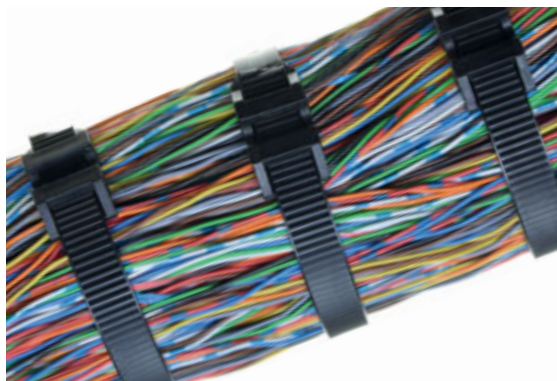

RELEVANT STANDARD  
EN 62275



## Odvezljive vezice

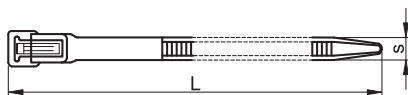
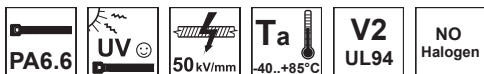

TRACON						
<b>180-NY</b>		<b>181-NY</b>		200 × 7.5 mm	10-50 mm	10-45 N
<b>260-NY</b>		<b>261-NY</b>		250 × 7.5 mm	10-65 mm	10-45 N
<b>280-NY</b>		<b>281-NY</b>		300 × 7.5 mm	10-70 mm	10-45 N
<b>350-NY</b>		<b>351-NY</b>		350 × 8 mm	10-120 mm	10-45 N



RELEVANT STANDARD  
EN 62275

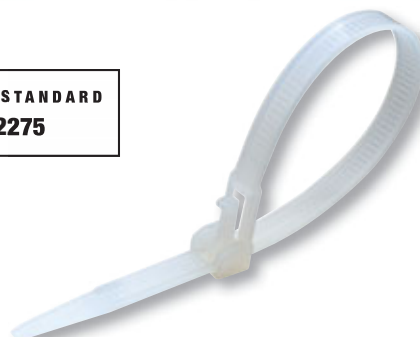

## Odvezljive krogične vezice

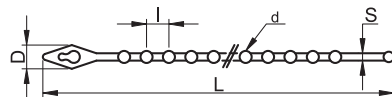
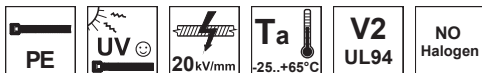

TRACON		L × S (mm)	d (mm)	D (mm)	l (mm)		
120N-GY	120F-GY	120 × 1.3	2.5	5.5	3	6-25 mm	40 N
150N-GY	150F-GY	150 × 2	3	7.5	4.5	8-35 mm	40 N
180N-GY	180F-GY	180 × 2	3	7.5	4.5	8-45 mm	40 N



RELEVANT STANDARD  
EN 62275



## Vezice z napisno ploščico

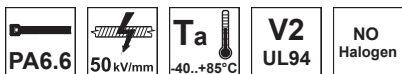

TRACON	L × S (mm)	a (mm)	b (mm)		
190J	190 × 3.6	27	13	10-48 mm	70 N
120J	110 × 2.5	8	25	1-20 mm	40 N
200J	210 × 2.5	15	30	5-45 mm	40 N

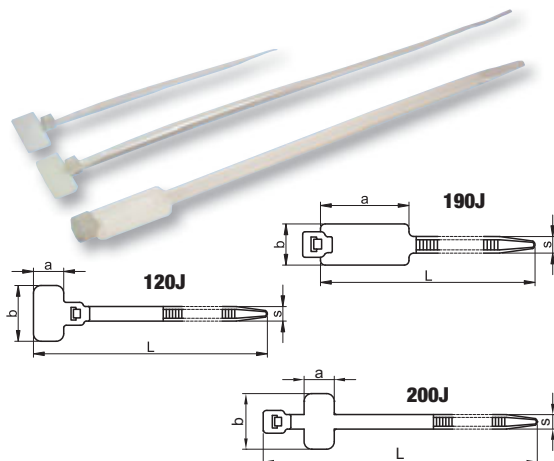

## Vezica za pritrjevanje na panele

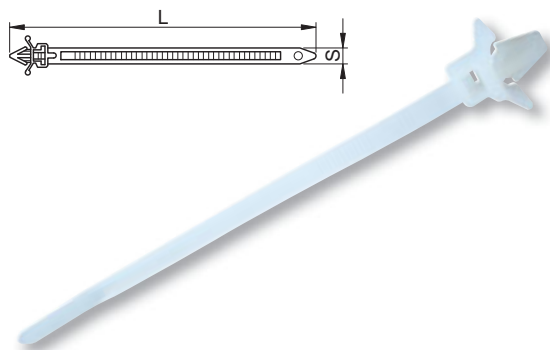
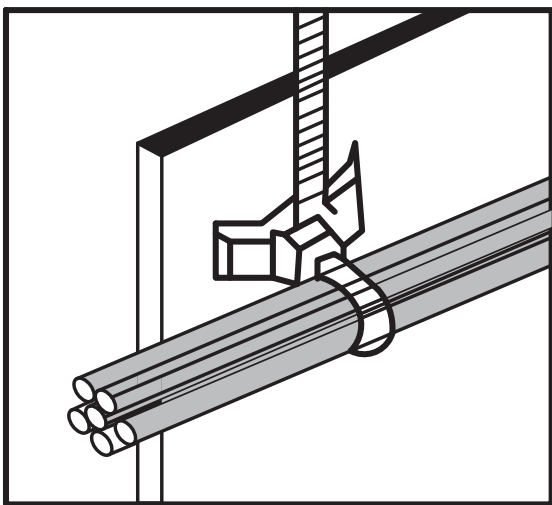
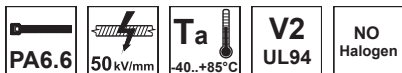

RELEVANT STANDARD  
EN 62275



## Vijačni podstavki za vezice, možna pritrditev vezice z dveh strani

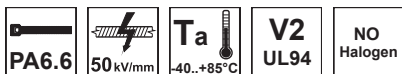

TRACON	a (mm)	b (mm)	L (mm)	d (mm)	D (mm)
CSTALP	15	10	5.1	3.5	7
CSTALP-3	12.8	7	4	3.3	5.8
CSTALP-2	23	16	9	6.3	9.8

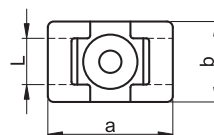
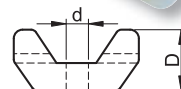
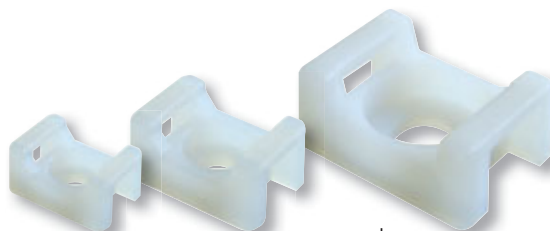
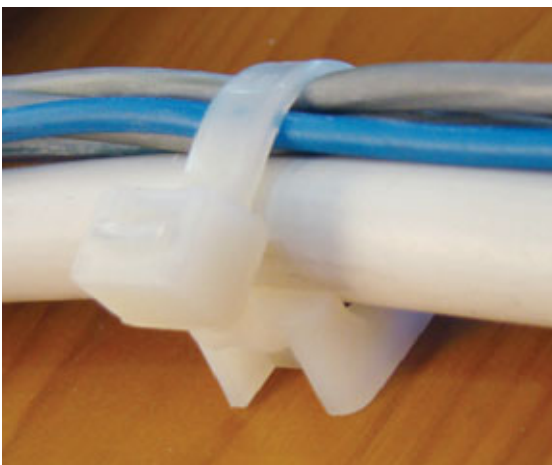



## Samolepilni vijačni podstavki za vezice, možna pritrditev vezice z dveh strani

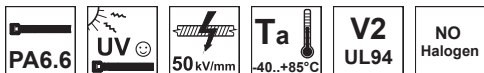

TRACON		a (mm)	b (mm)	L (mm)	d (mm)	D (mm)
TALP190-2		18.7	18.7	4	4.4	5.7
TALP191-2		18.7	18.7	4	4.4	5.7
TALP270-2		26.5	26.5	5.8	4.3	8.1
TALP271-2		26.5	26.5	5.8	4.3	8.1

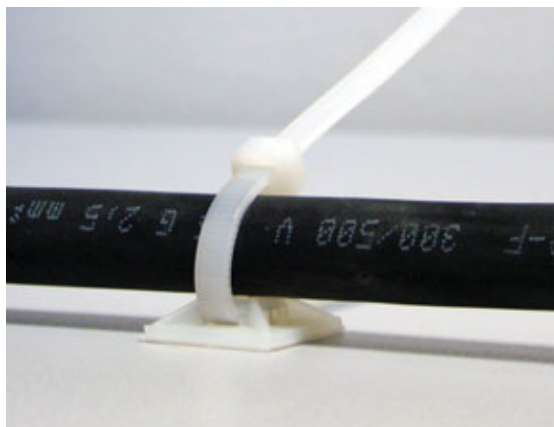
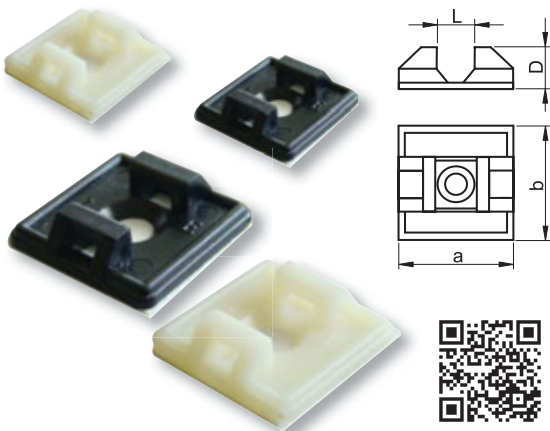

## Samolepilni vijačni podstavki za vezice, možna pritrditev vezice z štirih strani

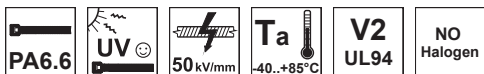

TRACON		a (mm)	b (mm)	L (mm)	d (mm)	D (mm)
TALP190		20	20	5	2.9	6.1
TALP191		20	20	5	2.9	6.1
TALP270		25	25	6.2	3.5	7.5
TALP271		25	25	6.2	3.5	7.5

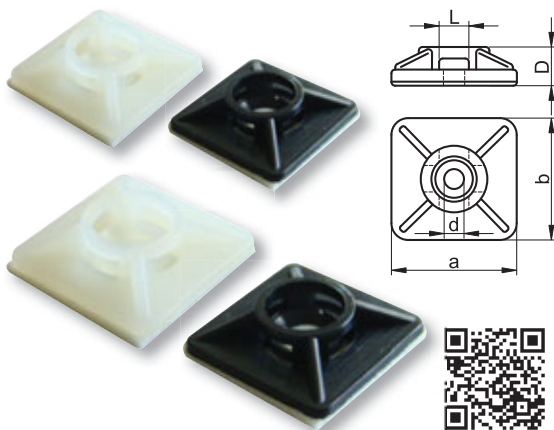

### Zidni vložki za vezice

PA6.6 
 UV 
 50 kV/mm 
 Ta -40..+85°C 
 V2 UL94 
 NO Halogen

Razlaga piktogramov 
 **C/0**

TRACON			a (mm)	b (mm)	c (mm)	W <sub>1</sub> (mm)	W <sub>2</sub> (mm)	L (mm)	D (mm)
5458		8 mm	10.6	6.3	3.1	12.8	12.6	43.8	9.9
5458N		8 mm	6.4	6.5	2.2	9.8	9.2	35.7	7.7

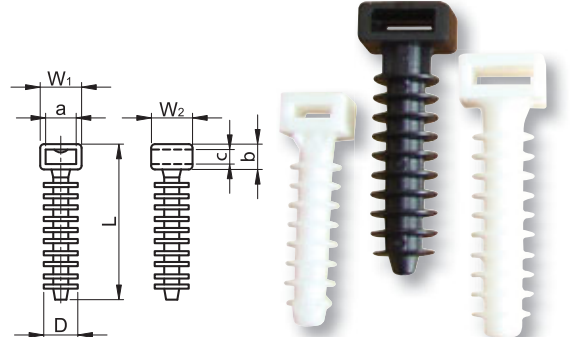
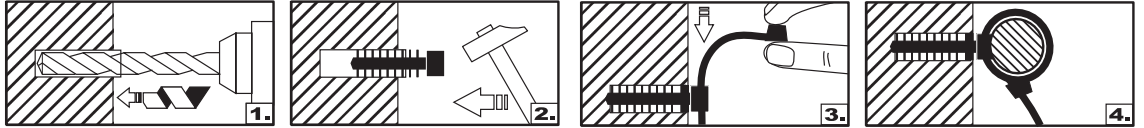

### Udarne objemke in zidni vložki za vezice

PA6.6 
 50 kV/mm 
 Ta -40..+85°C 
 V2 UL94 
 NO Halogen



Razlaga piktogramov 
 **C/0**

TRACON			A (mm)	B (mm)	D (mm)	
TBK-3	RAL 7035	180 × 7.5 mm	16-32 mm	17.6	24.5	150 N
TBK-4	RAL 7035	280 × 7.5 mm	40-63 mm	17.6	40.5	150 N

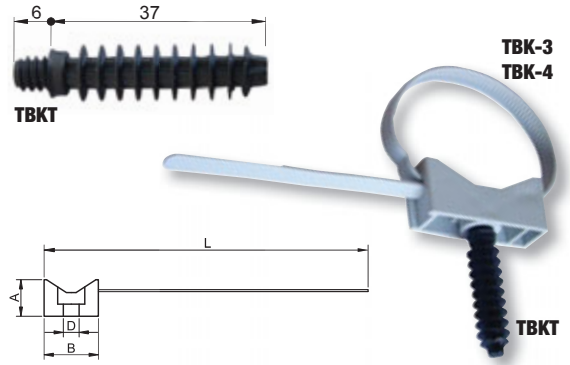
TRACON			d
TBKT		6-7 mm	



### Objemke za kable, z žebljem, ni za beton

TRACON			a (mm)	b (mm)
100 pcs 	20 pcs 			
NOF	NOF-20		2.5	4.5
N1	N1-20		6	7.3
N2	N2-20		8	8.1
N3	N3-20		9	8.3
N4	N4-20		11	10



N1..N4

NOF

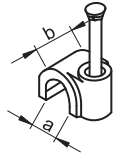
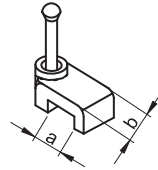



### Skobe za pritrjevanje cevi, sestavljive



Razlaga piktogramov

C/O

TRACON		D (mm)	W (mm)	L (mm)	H (mm)	
CSS-16		16	29.3	12.9	21.7	3/8" (coll)
CSS-20		20	33	12.9	24.2	1/2" (coll)
CSS-25		25	37.5	12.9	27.9	3/4" (coll)

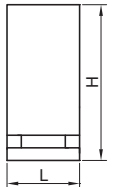
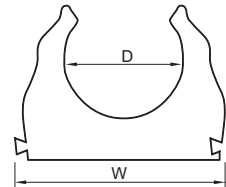

### Pritrjevalci kablov in cevi, odpirajoči, samolepilni



Razlaga piktogramov

C/O

TRACON		d (mm)	W (mm)	L (mm)
TKCR-0708		7-8	20	25

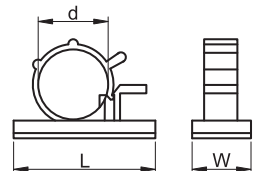
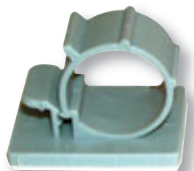

## Pritrjevalci kablov in cevi, odpirajoči, vijačni

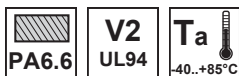

TRACON		d (mm)	L (mm)	H (mm)
TKCRZ-12		12	28	24.5
TKCRZ-15		15	28	28.5
TKCRZ-18		18	28	33
TKCRZ-20		20	28	34
TKCRZ-22		22	34	37
TKCRZ-28		28	38,5	45
TKCRZ-32		32	38	47.5
TKCRZ-35		35	41	49



## Skobe za pritrdjevanje kablov in cevi, sestavljive, zaprte

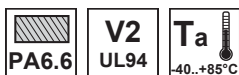

TRACON		a (mm)	b (mm)	L (mm)	I (mm)	H (mm)	W (mm)
BCSV-3		10-18	18.6	26.4	16.2	19.8-37.5	17.7
BCSV-4		19-31	28.8	39.4	15.1	39.5-51.6	18.2



## Rebrasti zidni vložki za pritrdjevanje kablov

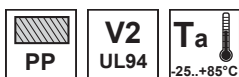

TRACON		d <sub>1</sub> (mm)	d <sub>2</sub> (mm)	B (mm)	L (mm)
KRT		6	6	10	36.5
KRT8		8	7.7	12.2	42.7

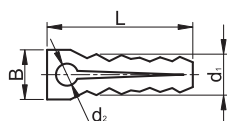

## Zidni vložki z robom s kavljem ali kljuko



V2  
UL94



TRACON		D × L (mm)	d (mm)	I <sub>1</sub> (mm)	I <sub>2</sub> (mm)	B (mm)
T6H		6 × 30	3.3	37	24.2	15.4
T6K		6 × 30	3.3	38.5	10	13.4

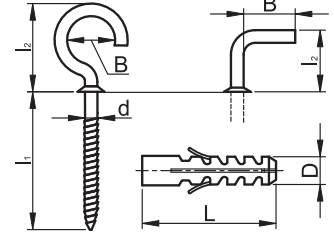

## Zidni vložki z robom in vijakom s šestkotno glavo s podložko



V2  
UL94



TRACON	D × L (mm)	d × l (mm)
T10080P	10 × 80	6.8 × 95
T10100P	10 × 100	6.8 × 115
T10120P	10 × 120	6.8 × 135
T10140P	10 × 140	6.8 × 155
T10160P	10 × 160	6.8 × 175
T10200P	10 × 200	6.8 × 215
T10240P	10 × 240	6.8 × 255
T10300P	10 × 300	6.8 × 315

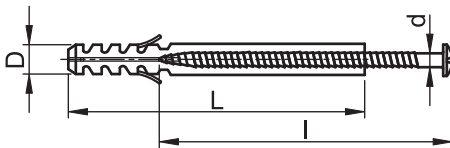

## Visoko vzdržljivi zidni vložek iz umetne mase

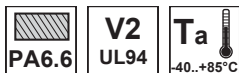

TRACON	D × L (mm)	d × l (mm)*
T5-UNI	5 × 25	3.5 × 35
T6-UNI	6 × 30	4 × 40
T8-UNI	8 × 40	5 × 50
T10-UNI	10 × 50	6 × 60

\* Priporočene dimenzije vijaka.

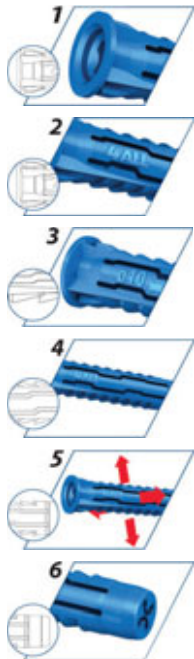

1. Svojevrsna notranja oblikovanost za zelo dobro prileganje vijaka.

2. Varovala pred zasokom omogočajo visoko silo oprijema v vseh, tudi v labilnih gradbenih materialih.

3. Zobje pod glavo povečujejo varno pritrditev ob sočasnem dobrem stiku v vseh materialih.

4. Razcepni del je tako oblikovan, da se v votlih materialih odpre in s tem odlično zasidra.

5. 4-smerno razpiranje omogoča rabo v vseh materialih in tipih sten.

6. Ojačana konica zagotavlja ustrezno sidranje med in po montaži.



Beton

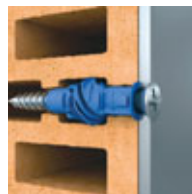

Votla opeka

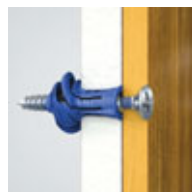

Zidna plošča

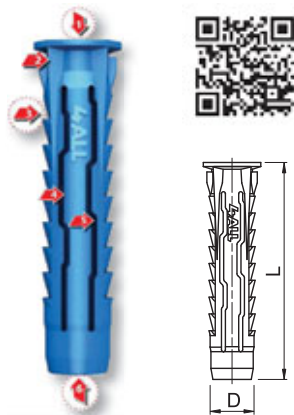

## Zidni vložki za mavčne plošče

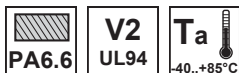

TRACON	Naziv	D × L (mm)	d × l (mm)*
GBT	Vijačni zidni vložek za mavčne plošče	16 × 36	4 × 35
GSZT	Odpiralni zidni vložek za mavčne plošče	10 × 55	4 × 50

\* Priporočene dimenzije vijaka.

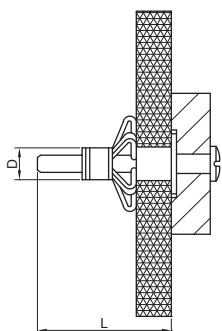

GSZT

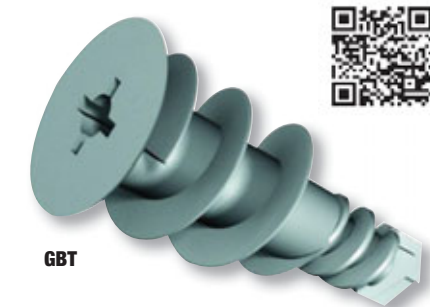

GBT

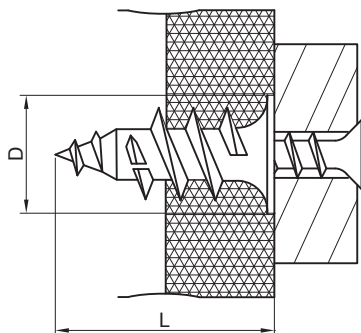

## Štirikotni zidni vložki



V2  
UL94

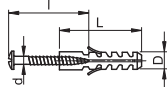

Razlaga  
piktogramov

C/O



TRACON		D x L (mm)	d x l (mm)
		6 x 23	2.6 x 30
<b>TN6</b>	<b>TNCS6</b>	6 x 23	2.6 x 30
<b>TN8</b>	<b>TNCS8</b>	8 x 34	3.5 x 38
<b>TN10</b>	<b>TNCS10</b>	10 x 42	4.4 x 46
<b>TN12</b>	<b>TNCS12</b>	12 x 52	5.4 x 61
<b>TN14</b>	-	14 x 65	-



## Zabijalni zidni vložki z vijakom



V2  
UL94

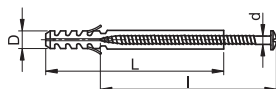

TRACON			TRACON		
	D x L (mm)	d x l (mm)		D x L (mm)	d x l (mm)
<b>TB525</b>	5 x 25	3.5 x 29	<b>TB845</b>	8 x 45	4.9 x 48
<b>TB535</b>	5 x 30	3.5 x 38	<b>TB860</b>	8 x 60	4.4 x 60
<b>TB545</b>	5 x 50	3.5 x 47	<b>TB875</b>	8 x 80	4.7 x 78
<b>TB635</b>	6 x 35	3.7 x 39	<b>TB8100</b>	8 x 100	4.7 x 102
<b>TB645</b>	6 x 40	3.7 x 48	<b>TB8120</b>	8 x 120	4.4 x 122
<b>TB655</b>	6 x 55	3.7 x 58	<b>TB8135</b>	8 x 135	4.4 x 137
<b>TB670</b>	6 x 60	3.7 x 73			

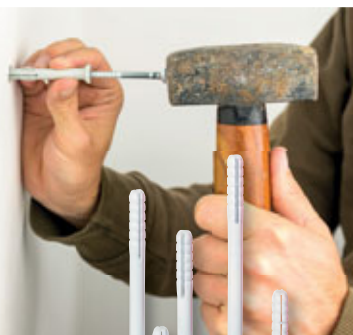

## Podaljšani zabijalni zidni vložki z vijakom



V2  
UL94

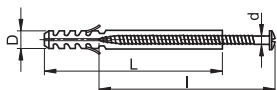

TRACON		D x L (mm)	d x l (mm)
-		8 x 100	5.3 x 104
<b>TH8100</b>	<b>THC8120</b>	8 x 120	5.5 x 126
<b>TH8120</b>	<b>THC8135</b>	8 x 135	5.4 x 134
<b>TH1080</b>	<b>THC1080</b>	10 x 80	6.8 x 85
<b>TH10100</b>	<b>THC10100</b>	10 x 100	6.8 x 105
<b>TH10115</b>	<b>THC10115</b>	10 x 115	6.8 x 119
<b>TH10135</b>	<b>THC10135</b>	10 x 135	6.8 x 141
<b>TH10160</b>	<b>THC10160</b>	10 x 160	7 x 165



## Standardni zidni vložki

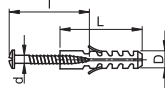

TRACON		D × L (mm)	d × l (mm)
		6 × 30	4 × 40
<b>T6-PA</b>	<b>T6CS-PA</b>	6 × 30	4 × 40
<b>T8-PA</b>	<b>T8CS-PA</b>	8 × 40	5 × 50
<b>T10-PA</b>	<b>T10CS-PA</b>	10 × 50	5.5 × 60
<b>T12-PA</b>	-	12 × 60	-
<b>T14-PA</b>	-	14 × 75	-

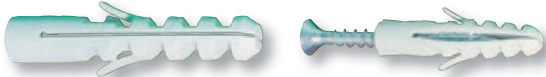

Razlaga piktogramov **C/O**

## Zidni vložki z robom

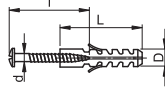

TRACON		D × L (mm)	d × l (mm)
-		6 × 30	4 × 40
<b>T6PCS-PA</b>		6 × 30	4 × 40
<b>T8P-PA</b>	<b>T8PCS-PA</b>	8 × 40	5 × 50
<b>T10P-PA</b>	<b>T10PCSPA</b>	10 × 50	5.5 × 60
<b>T12P-PA</b>	-	12 × 60	-

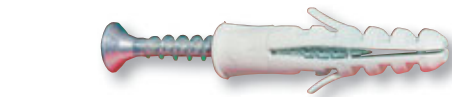

## Samozatezni zidni vložki

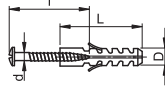

TRACON		D × L (mm)	d × l (mm)
		6 × 40	4 × 50
<b>TOP6</b>	<b>TOPCS6</b>	6 × 40	4 × 50
<b>TOP8</b>	<b>TOPCS8</b>	8 × 50	5 × 60
<b>TOP10</b>	<b>TOPCS10</b>	10 × 60	6 × 70



**PROSIMO, ODČITAJTE KODO!**

- Oglejte si novosti
- Bodite na tekočem



Naša paleta izdelkov se nenehno širi!  
 Katalog odraža stanje aprila 2019.  
 Za ažurne informacije obiščite  
 našo spletno stran!



## Stropni vijaki

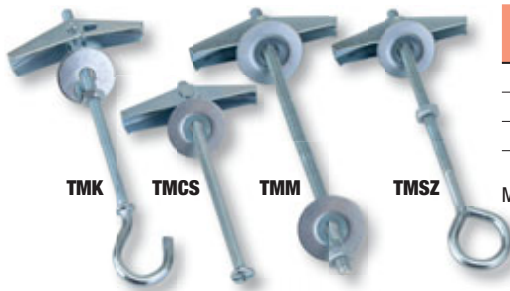

TMK

TMCS

TMM

TMSZ

TRACON	d (mm)	L (mm)	a (mm)	B (mm)	
TMK	M4	95	20	14	200 N
TMCS	M4	81	20	–	800 N
TMM	M4	100	20	–	800 N
TMSZ	M4	93	20	14	200 N

Material: kromirano jeklo

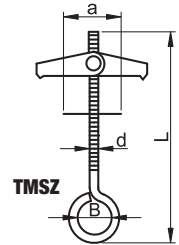
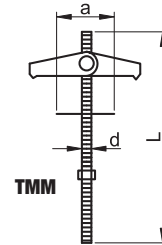
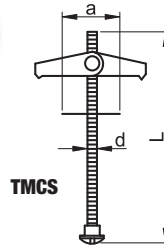
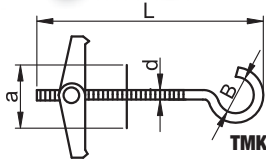

## Jekleni vložki za oblikovanje zanke iz jeklene vrvi

TRACON	W (mm)	l (mm)	L (mm)	c (mm)	s (mm)	
SZIV-3	4.5	41.6	46.3	17	1	1 – 3 mm
SZIV-4	5.5	37.7	41.7	15	1	3 – 4 mm
SZIV-5	6.2	37.8	42.4	15	1	4 – 5 mm
SZIV-6	9	42.8	47.5	18.1	1	5 – 6 mm
SZIV-8	9.4	47.7	54.5	19.2	1.5	6 – 7 mm
SZIV-10	12.1	53.8	59.7	21.9	1.5	7 – 9 mm
SZIV-12	17.1	62.4	68.5	28.8	1.5	9 – 12 mm
SZIV-16	21.1	75.7	82.9	39.2	2	12 – 14 mm
SZIV-19	21.6	80.6	90.3	42.2	2.3	16 – 19 mm

Material: jeklo

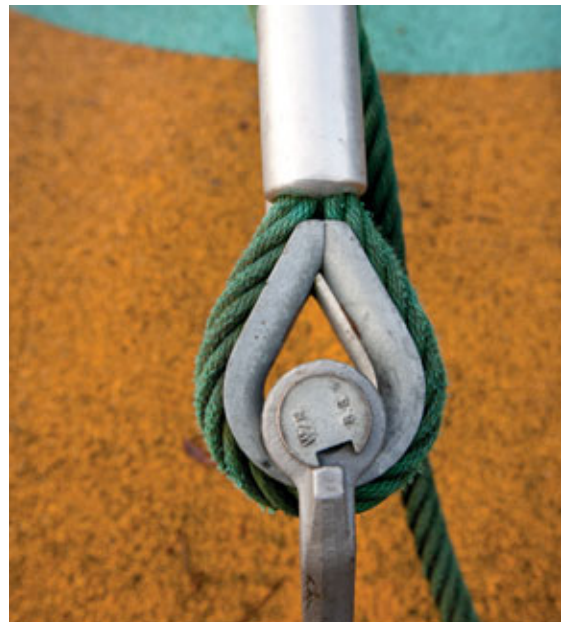
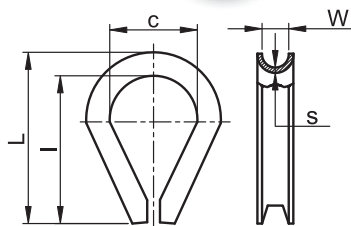

## Jekleni kavelj

TRACON	d (mm)	L (mm)	l (mm)	m (mm)	D (mm)	
HR3-25	3	26	20.2	3	7	320 N
HR3-30	3	31.1	25.5	4.8	8.8	320 N
HR4-30	4	33.4	25.5	4.8	10	575 N
HR4-35	4	35.3	27.5	5.2	10.2	575 N
HR4-40	4	41	33.3	5.9	10.9	575 N
HR5-45	4.8	46	36.7	6.6	12.5	730 N
HR5-50	5	53.5	44	10.3	15.3	885 N
HR6-80	6	80	69	12	24	1250 N
HR8-100	8	104	88	17	31	2000 N

Material: jeklo

Razlaga  
piktogramov

C/O

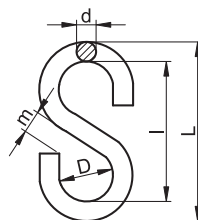

## Spojne "U" objemke za jeklene vrvi

TRACON	d (mm)	D (mm)	W (mm)	H (mm)	h (mm)	L (mm)	 mm
U03	M4	5.4	9.5	20.4	7.3	18	2-3 mm
U05	M5	7.2	9.6	24.2	7.5	21.5	3.2-5 mm
U06	M5	8.0	11.2	24.2	9.5	23.8	4.5-7 mm
U08	M6	9	12.9	35.4	10.4	27.4	6.3-8 mm
U09	M8	10.5	16.6	37.3	12.7	33	8-9 mm
U11	M8	11	18.4	41	16	36.4	10-11 mm
U13	M10	14.8	20.6	54.7	18.7	42.2	12-14 mm
U14	M10	14.9	24.2	55.2	23	43.7	12-14 mm
U16	M10	18.2	26	62	25.2	49.9	14-16 mm
U19	M12	21.5	29.7	76.8	30.2	54.4	16-19 mm
U22	M12	21.5	31	77.8	33.2	56.7	19-22 mm
U25	M14	27.7	32.8	95.7	34.5	63.3	22-25 mm

Material: U objemka – jeklo, telo spone – zlitina

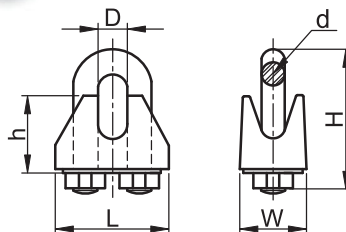

## Spone jeklene vrvi, enojne

TRACON	d (mm)	b (mm)	B (mm)	H (mm)	L (mm)	k (mm)
BSZ1-2	M4	5.1	13.6	6.1	17.2	13
BSZ1-3	M4	6.4	15.3	7	18.4	13.6
BSZ1-4	M5	10	16.6	6.5	21	17.4
BSZ1-5	M5	10.4	18.7	8.9	24.4	16.9
BSZ1-6	M6	12.5	23.3	9.6	30.2	21.6
BSZ1-8	M8	18.6	30.4	13.5	36.5	29.2

Material: jeklo

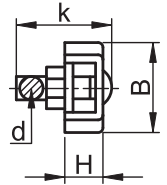
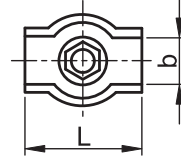

## Spone jeklene vrvi, dvojne

TRACON	d (mm)	b (mm)	B (mm)	H (mm)	L (mm)	k (mm)
BSZ2-2	M4	5.8	12.9	5	36.6	13.4
BSZ2-3	M4	6.4	15.3	6.7	35.2	13.5
BSZ2-4	M5	8.4	17.5	7.1	40	17.6
BSZ2-5	M5	11.9	20.4	8.8	48.8	19.6
BSZ2-6	M6	12.5	23.3	9.6	60.5	21.6
BSZ2-8	M8	18.6	30.4	13.5	73	29.2

Material: jeklo

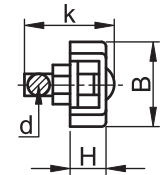
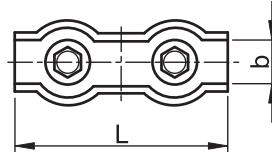

## Spone jeklene vrvi

TRACON	d (mm)	W (mm)	H (mm)	L (mm)	k (mm)	
AMAX3	M3	16.1	10.2	28.6	12.7	3 mm (1/8")
AMAX5	M5	17.5	10.7	30.5	12.4	5 mm (3/16")
AMAX6	M6	22.9	12.9	34.9	15.9	6 mm (1/4")

Material: jeklo

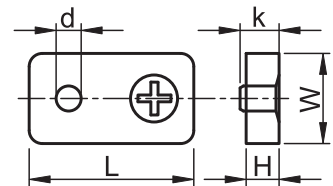

## Karabin, vzmetni

TRACON	d (mm)	D (mm)	W (mm)	L (mm)	m (mm)	
RKARA4	4.5	5.8	21.1	42.0	5.5	300 N
RKARA5	5	6.6	26	51.3	7.2	500 N
RKARA6	6	6.9	30.2	62.3	7.7	800 N
RKARA7	7	7.8	35.1	70.7	8.7	1100 N
RKARA8	8	8.1	40.4	80.5	10.2	1400 N
RKARA9	9	9.7	45	90.3	11.7	1700 N
RKARA10	10	11.1	47.3	99.8	13.4	2100 N
RKARA11	11	12.3	57.3	121.2	16.5	2500 N
RKARA12	12	13.9	63.2	142.5	20.8	2700 N
RKARA13	13	15.8	72.8	149.4	24.1	3000 N

Material: jeklo

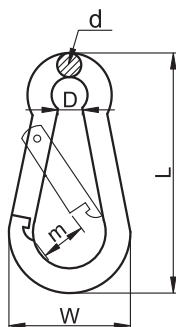



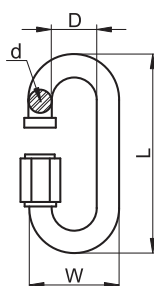

## Karabin, vijalni

TRACON	d (mm)	D (mm)	W (mm)	L (mm)	
CSKARA3,5	3.5	10.8	17.9	35.5	420 N
CSKARA4	4	11.6	19.7	40.6	850 N
CSKARA5	5	13.6	23.5	50.9	1270 N
CSKARA6	6	14.7	26.7	58.3	1700 N
CSKARA7	7	18.4	32	68.2	2550 N
CSKARA8	8	19.6	36	73.8	3100 N
CSKARA9	9	20.6	39.2	82.2	4250 N
CSKARA10	10	21.6	42.4	89.6	5100 N
CSKARA12	12	23.5	48.3	106.2	6400 N

Material: jeklo



## Napenjalci

TRACON			d (mm)	l (mm)	L (mm)	d (mm)	
 FSS550	 FSH550	 FHH550	5	50	92.6	7.8	750 N
FSS570	FSH570	FHH570	5	70	113	8	770 N
FSS660	FSH660	FHH660	6	60	112	10	1050 N
FSS6100	FSH6100	FHH6100	6	100	154	10.2	1800 N
FSS870	FSH870	FHH870	8	70	137	12.3	1200 N
FSS8110	FSH8110	FHH8110	8	110	176	12.3	2000 N
FSS10120	FSH10120	FHH10120	10	120	194	13.3	3000 N
FSS12130	FSH12130	FHH12130	12	130	224	18.3	4450 N
FSS16140	FSH16140	FHH16140	16	140	265	22	5950 N

Material: navoj - jeklo, telo - zlitina

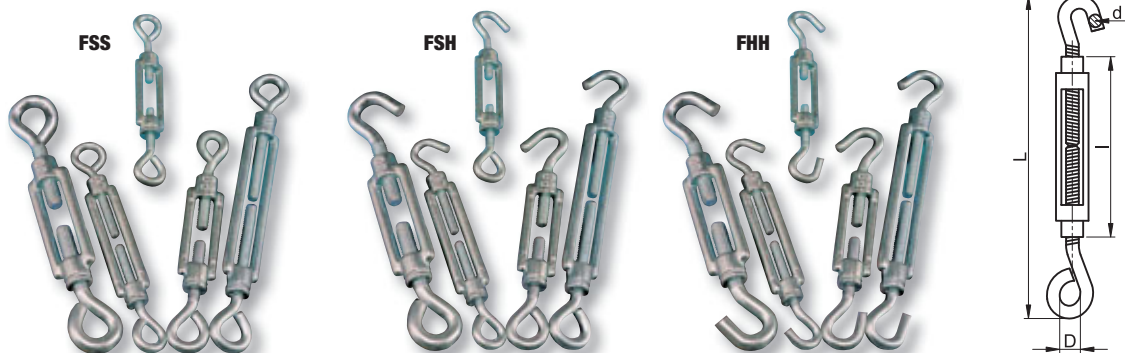

**PROSIMO, ODČITAJTE KODO!**

- Oglejte si novosti
- Bodite na tekočem

Naša paleta izdelkov se nenehno širi!  
 Katalog odraža stanje aprila 2019.  
 Za ažurne informacije obiščite  
 našo spletno stran!

## Zaščitne cevi za kable

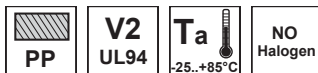

TRACON	d (mm)	D (mm)	s (mm)		
SPI6	6.2	8.6	1.9	1 m	6 mm
SPI8	8	10.9	2.4	1 m	8 mm
SPI10	10	13.2	2.9	1 m	10 mm
SPI12	12	15.4	2.9	1 m	12 mm
SPI15	15	17.1	2.9	1 m	15 mm
SPI20	20	24	3	1 m	20 mm
SPI25	25	28.7	3	1 m	25 mm

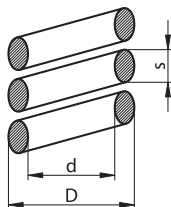

## Spiralni trakovi za povezavo kablov v snope



TRACON		D (mm)	d (mm)	W (mm)		
KSPI-4N	KSPI-4F	4.5	3.2	6.8	10 m	4...20 mm
KSPI-6N	KSPI-6F	6.9	5.3	10.3	10 m	7...40 mm
KSPI-8N	KSPI-8F	8.4	6.6	11.7	10 m	12...50 mm
KSPI-10N	KSPI-10F	10.2	8.2	13.4	10 m	13...70 mm
KSPI-12N	KSPI-12F	12.2	9.6	15.9	10 m	15...80 mm
KSPI-16N	KSPI-16F	15.7	12.4	21.6	10 m	20...120 mm

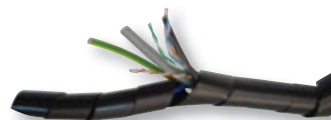
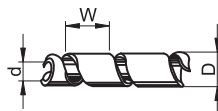

## Cevaste kabelske mreže iz umestne mase

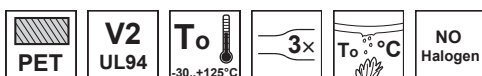

TRACON		
TKH-003	3 mm	2.4 – 6.4 mm
TKH-010	10 mm	4.8 – 15.9 mm
TKH-016	16 mm	9.5 – 25.4 mm
TKH-025	25 mm	15.9 – 36.1 mm
TKH-032	32 mm	19.1 – 44.5 mm



Njena prednost je, da lahko poleg mehanske zaščite, s svojo visoko stopnjo upogljivosti in raztegljivosti odlično spremlja potek kablov in morebitne spremembe presekov. Rez na ustrezno dolžino izvedemo s segretim nožem. Na tak način se rez ne bo zavihal in razparal. Tkanina ne veže nase ne vročine, ne vlage.