

				
Klasična izvedba kablskih vezic 2	Barvne kablске vezice 3	Vezice s kovinskim jezičkom odporne na UV svetlobo 4	Odvezljive vezice 5	Odvezljiva vezica s kroglicami 5
				
Toplotno odporne kablске vezice 6	Negorljive kablске vezice 6	Vezica za pritrjevanje na panele 6	Vezice z napisno ploščico 7	Jeklene kablске vezice 7
				
Vezica s podstavkom za pritrditvev na rob 8	Sprijemalni razvrščevalnik kablov na 9	Samolepilni pritrjevalec za kable 9	Vijačni podstavki za vezice, pritrditvev z 2 strani 10	Zidni vložki za vezice 11
				
Objemke za kable z žebrijem 12	Vrstni klipi za pričvrstitvev kablov/cevi 12	Rebrasta sponka za pritrjevanje vodov 13	Zidni vložki z robom s kavljem ali kjuko 14	Zidni vložki z robom in vijakom s šestkotno glavo s podložko 14
				
Udarne vložki za mavčne plošče 14	Visoko vzdržljiv najlonski zidni vložek za vse vrste materialov 15	Vijačni vložek za mavčno dozo 15	Zidni vložek, zabijalni +vijak 16	Vložek z robom 17
				
Jekleni vložki za oblikovanje zanke iz jeklene vrvi 18	Jekleni kavelj 19	Spone »U« jeklene vrvi 19	Spone jeklene vrvi, dvojne 20	Karabin, vzmetni 21
				
Zategovalec 22	Zaščitne cevi za kable 23	Samozapiralna cevasta kablсka mreža 23	Označevalne plombe 24	Plombe za števice električnen energije 24

C
Q

Razlaga piktogramov v glavi tabel



Piktogrami tehničnih podatkov

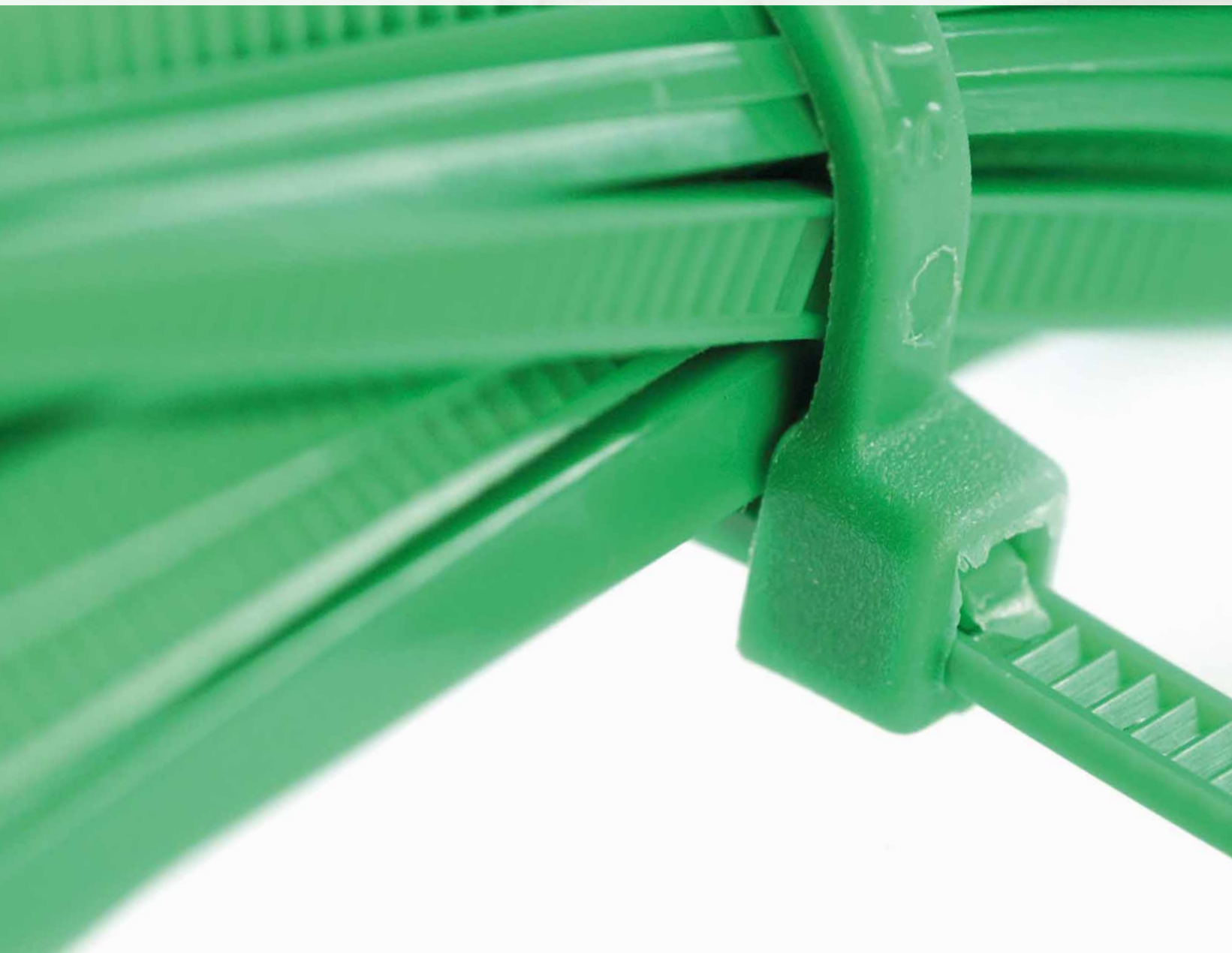
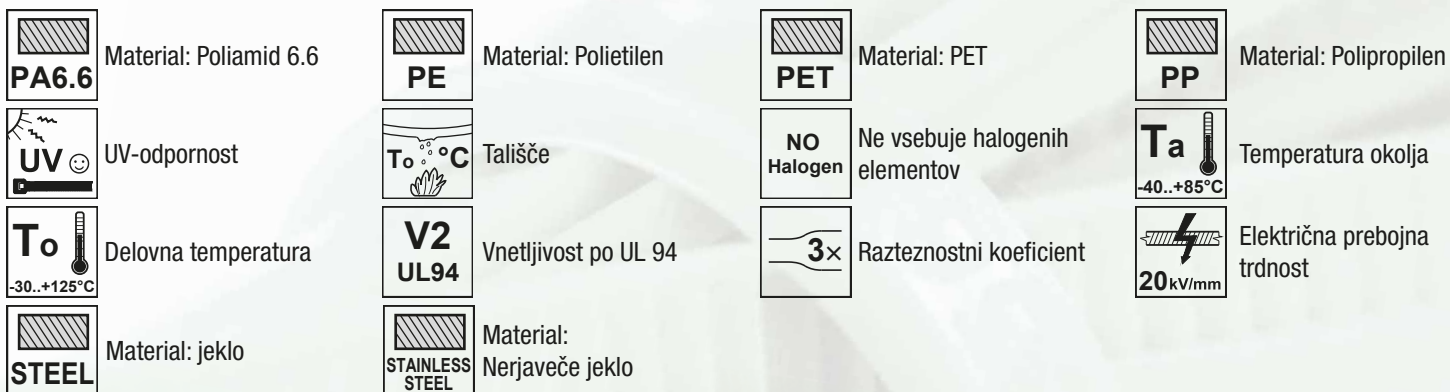

Klasična izvedba kabelskih vezic

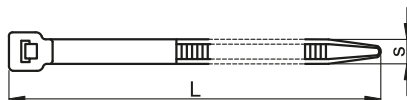
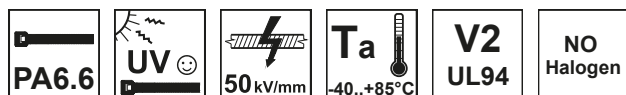

TRACON						
80PR		81PR		75 × 2.2 mm	0.75-15 mm	35 N
120PR		121PR		98 × 2.5 mm	1-21 mm	45 N
130PR		131PR		135 × 2.6 mm	1-32 mm	45 N
150PR		151PR		140 × 3.6 mm	2-36 mm	80 N
160PR		161PR		160 × 2.6 mm	1-40 mm	45 N
180PR		181PR		180 × 7.8 mm	3.5-45 mm	250 N
200PR		201PR		200 × 2.6 mm	1-52 mm	45 N
170PR		171PR		200 × 3.6 mm	2-50 mm	80 N
190PR		191PR		200 × 4.8 mm	3-50 mm	110 N
250PR		251PR		250 × 4.8 mm	3-68 mm	110 N
280PR		281PR		280 × 8.0 mm	4-65 mm	180 N
230PR		231PR		290 × 3.6 mm	2-80 mm	80 N
210PR		211PR		290 × 4.8 mm	3.5-79 mm	110 N
300PR		301PR		300 × 7.8 mm	5-80 mm	250 N
220PR		221PR		360 × 4.8 mm	3.5-103 mm	110 N
260PR		261PR		365 × 7.8 mm	8-100 mm	250 N
370PR		371PR		370 × 3.6 mm	5-108 mm	80 N
430PR		431PR		430 × 4.8 mm	3.5-115 mm	110 N
450PR		451PR		450 × 7.8 mm	35-130 mm	250 N
530PR		531PR		550 × 8 mm	10-160 mm	250 N
760PR		761PR		780 × 9 mm	35-233 mm	350 N
850PR		851PR		850 × 12.6 mm	40-255 mm	450 N
1000PR		1001PR		1000 × 12.6 mm	40-302 mm	450 N
270PR		271PR		260 × 2.5 mm	3-73 mm	45 N
550PR		551PR		550 × 4.6 mm	4-160 mm	110 N
610PR		611PR		610 × 8.8 mm	9-181 mm	350 N
580PR		581PR		580 × 12.4 mm	9-168 mm	450 N

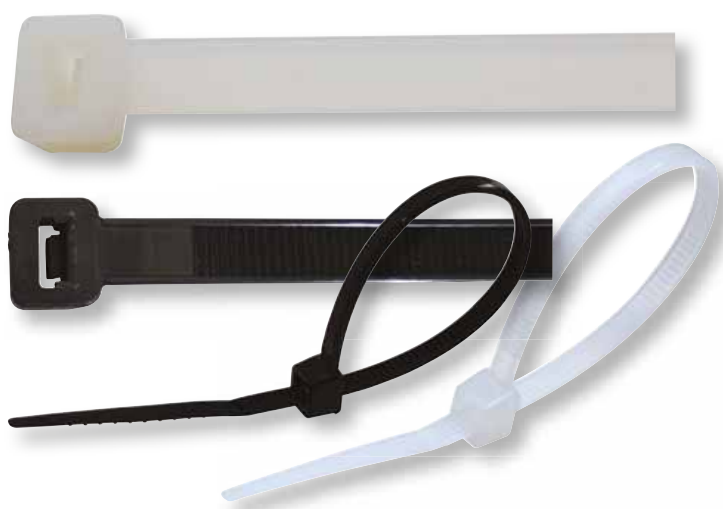

RELEVANT STANDARD
EN 62275



Trajna odpornost na: ogljikovodikove derivate, organska topila, alkohole
 Omejena odpornost na: organske kisline, baze, anorganske soli, ostale organske materiale
 Neodpornost na: anorganske kisline in na oksidirajoča sredstva!



B/18

TG008

TG007



Barvne kabelske vezice

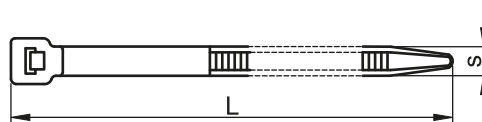
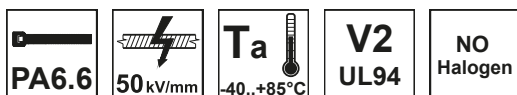

TRACON					
120K		98 × 2.5 mm	1-21 mm	45 N	
150P		140 × 3.6 mm	2-36 mm	80 N	
150Z		140 × 3.6 mm	2-36 mm	80 N	
200K		200 × 2.6 mm	1-52 mm	45 N	
170K		200 × 3.6 mm	2-50 mm	80 N	
170P		200 × 3.6 mm	2-50 mm	80 N	
190K		200 × 4.8 mm	3-50 mm	110 N	
230NZ		290 × 3.6 mm	2-80 mm	80 N	
170Z		203 × 3.6 mm	2 - 52 mm	80 N	
190Z		203 × 4.6 mm	2 - 52 mm	110 N	

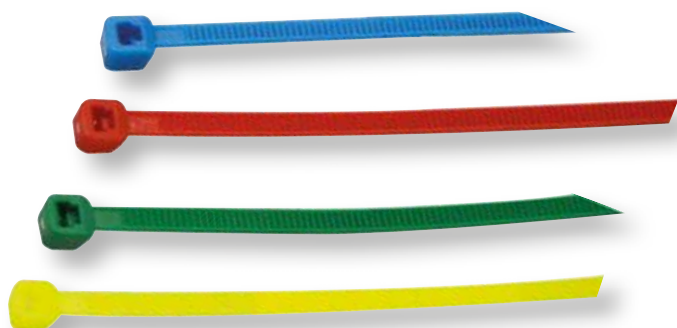

RELEVANT STANDARD
EN 62275

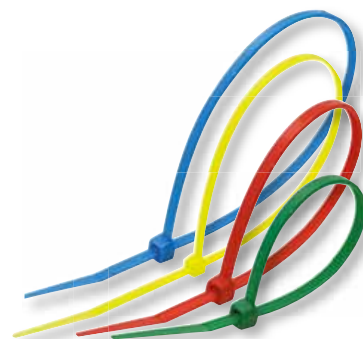

Vezice s kovinskim jezičkom

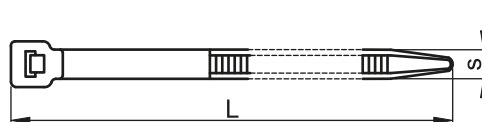
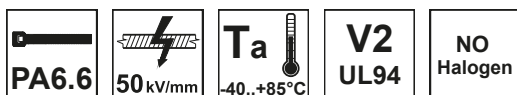

TRACON				
T92		92 × 2.4 mm	2-16 mm	35 N
T140		140 × 3.6 mm	2-29 mm	75 N
T186		186 × 4.8 mm	3.5-45 mm	110 N
T200		200 × 2.4 mm	2-50 mm	35 N
T208		208 × 3.6 mm	2-50 mm	75 N
T281		281 × 3.6 mm	2-76 mm	75 N
T293		293 × 4.8 mm	3.5-78 mm	110 N
T338		338 × 7.6 mm	3.5-120 mm	110 N
T360		360 × 4.8 mm	3.5-102 mm	110 N



Vežice s kovinskim jezičkom, odporne na UV svetlobo

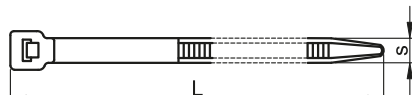

Razlaga piktogramov

C/O

TRACON				
TU92		92 × 2.4 mm	2-16 mm	35 N
TU140		140 × 3.6 mm	2-29 mm	75 N
TU186		186 × 4.8 mm	3.5-45 mm	110 N
TU200		200 × 2.4 mm	2-50 mm	35 N
TU208		208 × 3.6 mm	2-50 mm	75 N
TU281		281 × 3.6 mm	2-76 mm	75 N
TU293		293 × 4.8 mm	3.5-78 mm	110 N
TU338		338 × 7.6 mm	3.5-120 mm	110 N
TU360		360 × 4.8 mm	3.5-102 mm	110 N



Vežice PA12

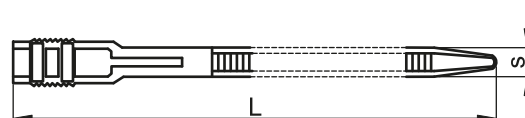

TRACON				
132-12		132 × 9.0 mm	4-27 mm	120 N
180-12		180 × 9.0 mm	5-45 mm	150 N
265-12		260 × 9.0 mm	25-65 mm	250 N
300-12		300 × 9.0 mm	25-80 mm	225 N
360-12		350 × 9.0 mm	25-93 mm	250 N



RELEVANT STANDARD
EN 62275



Odvezljive vezice

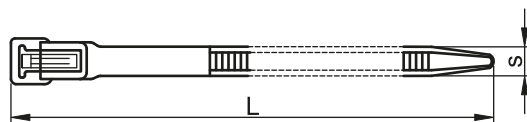
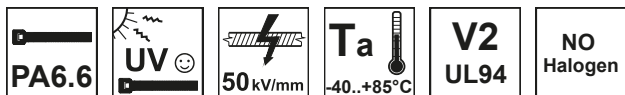

TRACON				
180-NY	181-NY	200 × 7.5 mm	10-50 mm	10-45 N
260-NY	261-NY	250 × 7.5 mm	10-65 mm	10-45 N
280-NY	281-NY	300 × 7.5 mm	10-70 mm	10-45 N
350-NY	351-NY	350 × 8 mm	10-120 mm	10-45 N



Odvezljive kroglične vezice

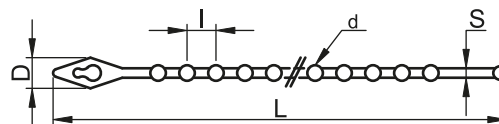
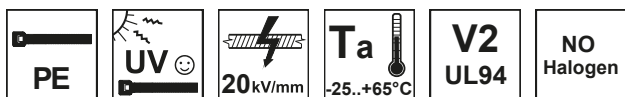

TRACON		L × S (mm)	d (mm)	D (mm)	l (mm)		
100N-GY	100F-GY	1.2 × 100	2.5	4.85	3	3 - 25 mm	45 N
120N-GY	120F-GY	120 × 1.3	2.5	5.5	3	6-25 mm	40 N
150N-GY	150F-GY	150 × 2	3	7.5	4.5	8-35 mm	40 N
160N-GY	160F-GY	1.7 × 150	2.6	7.73	4	4 - 38 mm	40 N
180N-GY	180F-GY	180 × 2	3	7.5	4.5	8-45 mm	40 N
200N-GY	200F-GY	1.8 × 200	2.5	7.63	5	5 - 59 mm	40 N



Toplotno odporne kabelske vezice

PA6.6
 50 kV/mm
 Ta
 -40..+105 °C
 V2 UL94
 NO Halogen

Razlaga piktogramov
 C/O

TRACON

260T 365 × 7.8 mm 8-100 mm 135 °C (5-8 min) 250 N

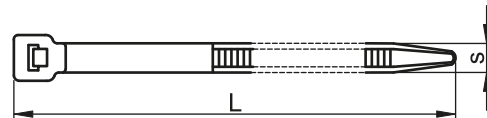
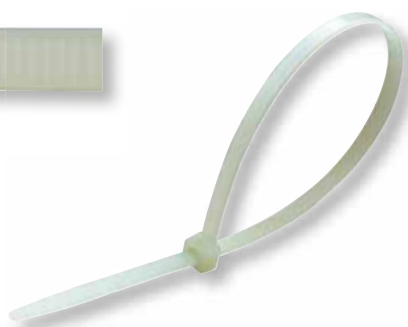

RELEVANT STANDARD
EN 62275

Negorljive kabelske vezice

PA6.6
 Ta
 -40..+85°C
 V2 UL94
 NO Halogen

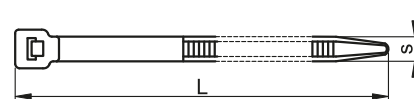

TRACON

150L	3.6 × 150mm	4 - 36 mm	80 N
200L	4.6 × 200mm	4 - 52 mm	110 N
300L	4 × 300mm	4 - 81 mm	110 N
380L	7.6 × 380mm	9 - 108 mm	250 N



Vezica za pritrjevanje na panele

PA6.6
 50 kV/mm
 Ta
 -40..+85°C
 V2 UL94
 NO Halogen

Razlaga piktogramov
 C/O

TRACON

BK-130 130 × 4.8 mm d=6 mm 3-25 mm 200 N

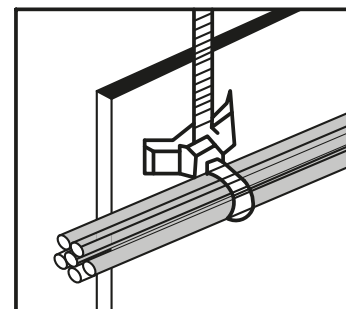
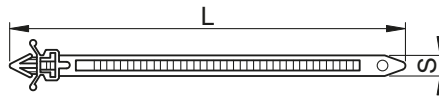
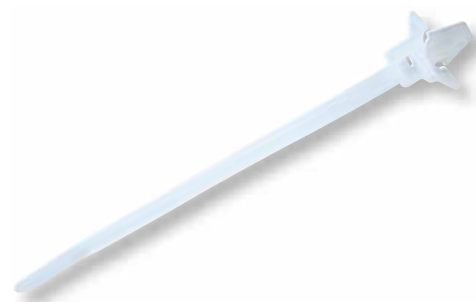

Vezice z napisno ploščico

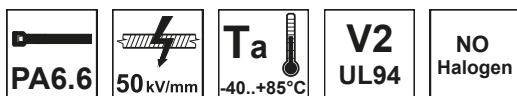

TRACON	L × S (mm)	a (mm)	b (mm)		
120J	110 × 2.5	8	25	1-20 mm	40 N
190J	190 × 3.6	27	13	10-48 mm	70 N
200J	210 × 2.5	15	30	5-45 mm	40 N

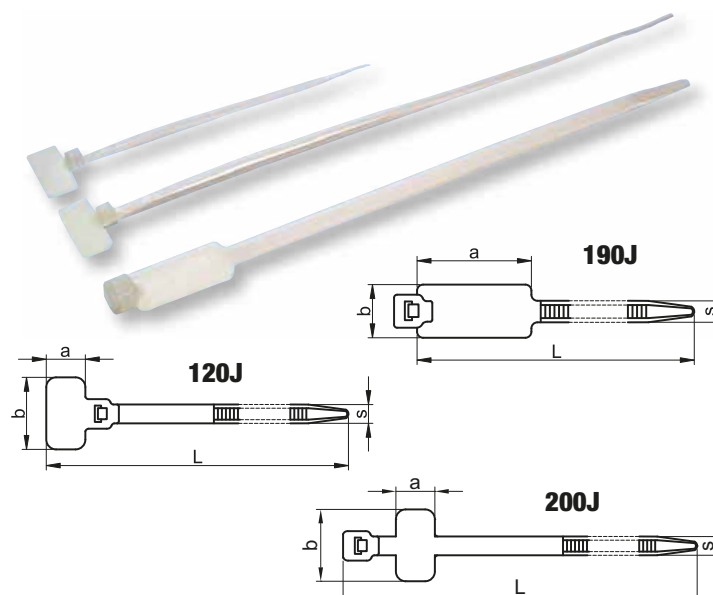

Jeklene kabelske vezice

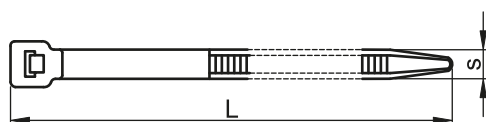

TRACON			
F125	125 × 4.6 mm	15 - 38 mm	350 N
F200	200 × 4.6 mm	15 - 61 mm	350 N
F201	200 × 7.9 mm	15 - 61 mm	450 N
F290	290 × 4.6 mm	15 - 90 mm	350 N
F291	290 × 7.9 mm	15 - 90 mm	450 N
F520	520 × 4.6 mm	15 - 163 mm	350 N
F521	520 × 7.9 mm	15 - 163 mm	450 N
F840	840 × 4.6 mm	15 - 265 mm	350 N
F841	840 × 7.9 mm	15 - 265 mm	450 N

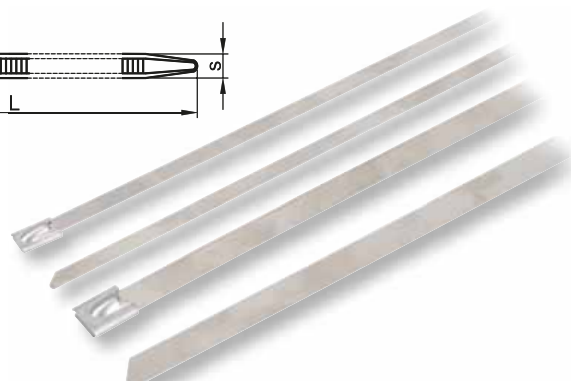
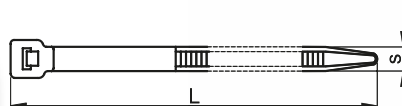

Vežice z vijačnim podstavkom za pritrditev

PA6.6
 Ta -40..+85°C
 V2 UL94

Razlaga piktogramov **C/O**

TRACON					
110-CS		110 × 2.5 mm	3 - 19 mm	45 N	M2.5
150-CS		150 × 3.6 mm	3 - 35 mm	80 N	M4
160-CS		160 × 4.8 mm	3 - 36 mm	110 N	M5
200-CS		200 × 4.8 mm	3 - 49 mm	110 N	M5
300-CS		300 × 4.8 mm	3 - 82 mm	110 N	M5
310-CS		300 × 7.6 mm	8 - 78 mm	250 N	M6
370-CS		370 × 4.8 mm	3 - 103 mm	110 N	M5
400-CS		400 × 7.6 mm	8 - 109 mm	250 N	M6

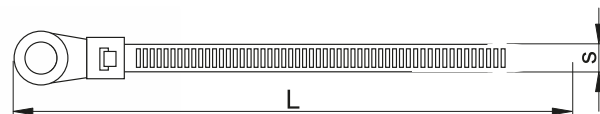

Vežice s podstavkom za pritrditev na rob

PA6.6
 Ta -40..+85°C
 V2 UL94
 NO Halogen

Razlaga piktogramov **C/O**

TRACON				
CSKT		4.8 × 200mm	3 - 49 mm	110 N

Maksimalna debelina roba 3 mm.



Sprijemalni razvrščevalniki kablov na ježek



Razlaga
piktogramov

C/O

TRACON			
TKR130		130 x 12,5 mm	35 mm
TKR200		200 x 12,5 mm	35 mm
TKR300		300 x 12,5 mm	89 mm
TKR310		300 x 17 mm	92 mm
TKR-12T		22,8 m x 12,5 mm	–
TKR-20T		25 m x 20 mm	–



TKR-12T
TKR-20T

Samolepilni pritrjevalci za kable



Razlaga
piktogramov

C/O

TRACON		L (mm)	W (mm)	H (mm)
OKT15		15	24	9
OKT20		20	24	9
OKT25		25	24	9
OKT28		28	24	9

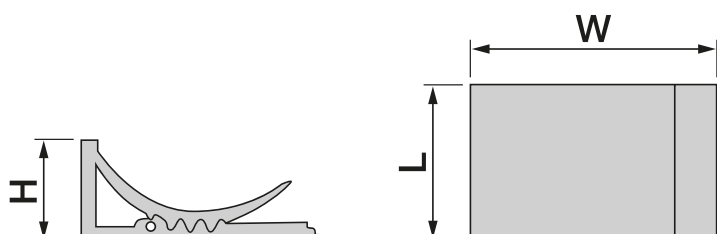

OKT28

OKT15

Vijačni podstavki za vezice, možna pritrditev vezice z dveh strani

PA6.6
 50 kV/mm
 Ta -40..+85°C
 V2 UL94
 NO Halogen

Razlaga piktogramov **C/O**

TRACON	a (mm)	b (mm)	L (mm)	d (mm)	D (mm)
CSTALP	15	10	5.1	3.5	7
CSTALP-3	12.8	7	4	3.3	5.8
CSTALP-2	23	16	9	6.3	9.8
CSTALP-4	16	11	5.3	3.5	7
CSTALP-5	22	15	8.3	5	9.5
CSTALP-6	26	16	9.5	5	10.7

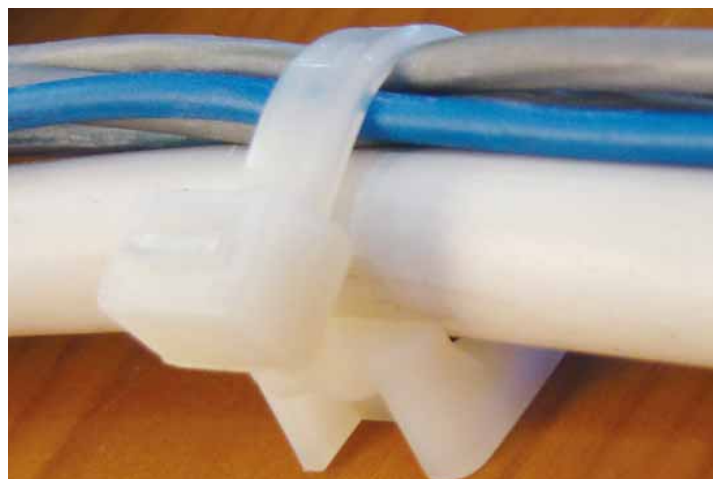
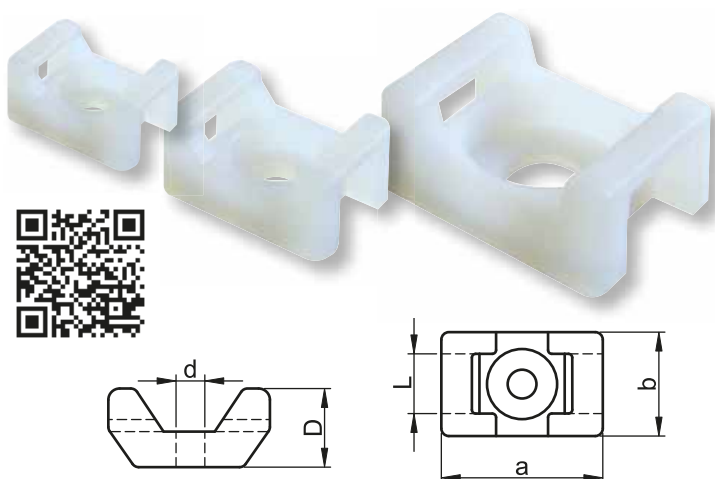

Samolepilni vijačni podstavki za vezice, možna pritrditev vezice z dveh strani

PA6.6
 UV
 50 kV/mm
 Ta -40..+85°C
 V2 UL94
 NO Halogen

Razlaga piktogramov **C/O**

TRACON		a (mm)	b (mm)	L (mm)	d (mm)	D (mm)
TALP190-2		18.7	18.7	4	4.4	5.7
TALP191-2		18.7	18.7	4	4.4	5.7
TALP270-2		26.5	26.5	5.8	4.3	8.1
TALP271-2		26.5	26.5	5.8	4.3	8.1

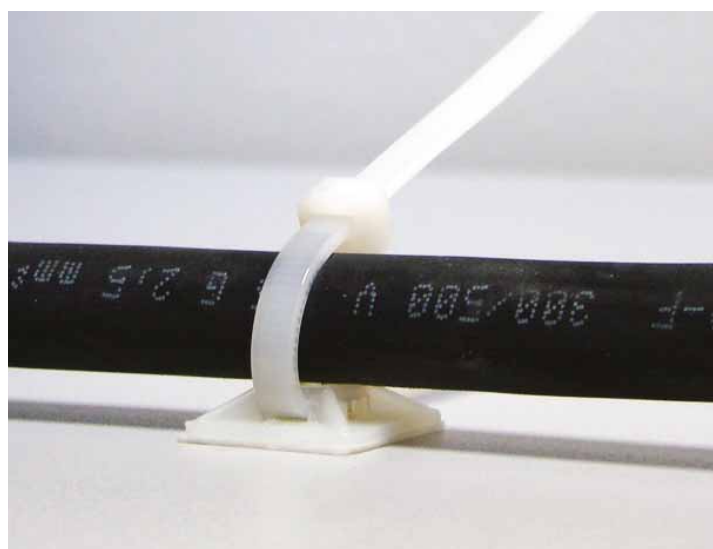
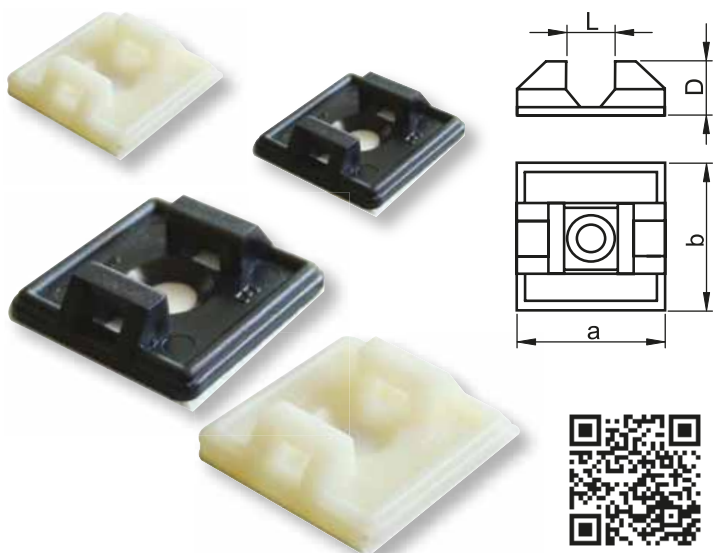

Samolepilni vijačni podstavki za vezice, možna pritrditev vezice z štirih strani

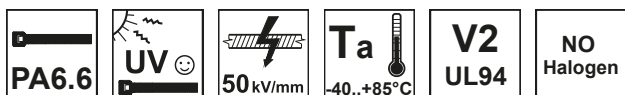

TRACON		a (mm)	b (mm)	L (mm)	d (mm)	D (mm)
TALP190		20	20	5	2.9	6.1
TALP191		20	20	5	2.9	6.1
TALP200		19	19	4.3	5	6
TALP201		19	19	4.3	5.7	6.5
TALP270		25	25	6.2	3.5	7.5
TALP271		25	25	6.2	3.5	7.5
TALP280		28	28	5.2	5.7	6.5
TALP281		28	28	5.2	5.7	6.5

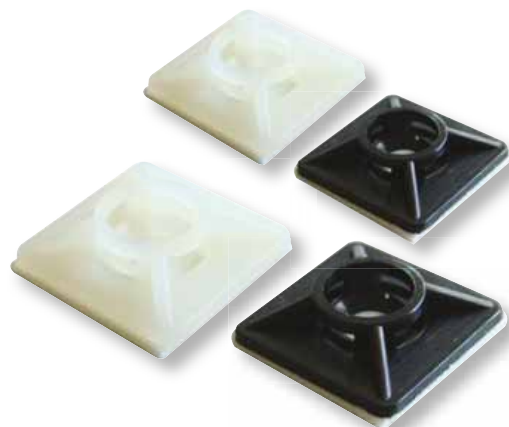
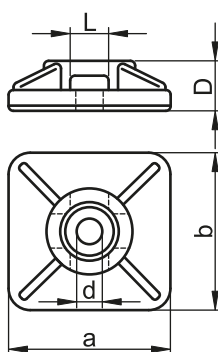

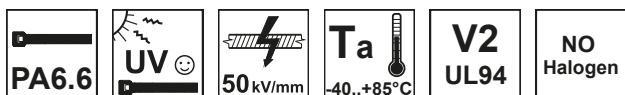

Zidni vložki za vezice



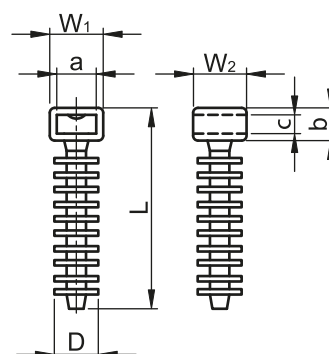
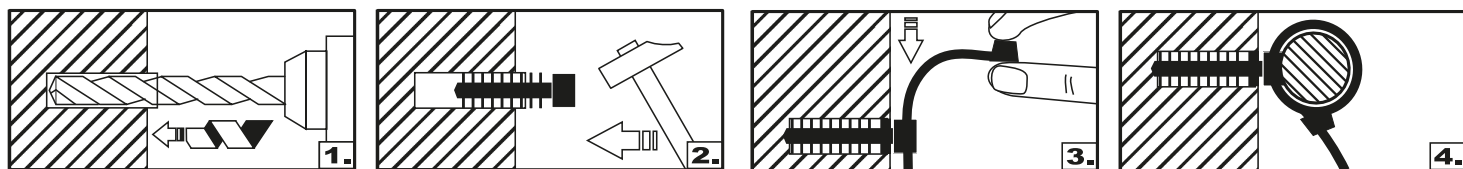

TRACON			a (mm)	b (mm)	c (mm)	W ₁ (mm)	W ₂ (mm)	L (mm)	D (mm)
5458		8 mm	10.6	6.3	3.1	12.8	12.6	43.8	9.9
5458N		7 mm	9.8	6.4	2.1	15.4	11.1	38.0	7.9
8138		7 mm	10.2	6.4	3	14.6	11	38	9.9
9843		8 mm	10.3	6.5	3.2	12.8	12.9	43.3	9.7



Objemke za kable, z žebljem, ni za beton



TRACON			a (mm)	b (mm)
100 pcs 	20 pcs 			
NOF	NOF-20		2.5	4.5
N1	N1-20		6	7.3
N2	N2-20		8	8.1
N3	N3-20		9	8.3
N4	N4-20		11	10

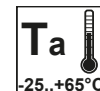

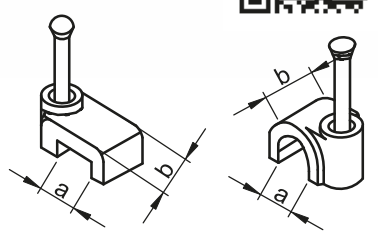





Skobe za pritrjevanje cevi, sestavljive







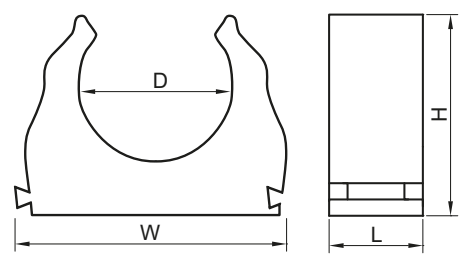

Razlaga piktogramov **C/O**

TRACON		D (mm)	W (mm)	L (mm)	H (mm)
CSS-16		16	29.3	12.9	21.7
CSS-20		20	33	12.9	24.2
CSS-25		25	37.5	12.9	27.9



Pritrjevalci kablov in cevi, odpirajoči, samolepilni







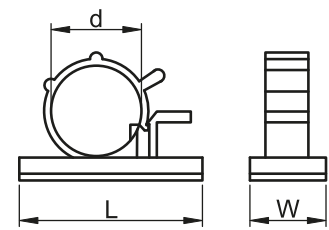

Razlaga piktogramov **C/O**

TRACON		d (mm)	W (mm)	L (mm)
TKCR-0708		7-8	20	25



Pritrjevalci kablov in cevi, odpirajoči, vijalni







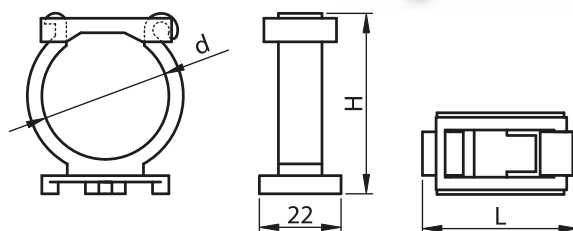



TRACON		d (mm)	L (mm)	H (mm)
TKCRZ-12		12	28	24.5
TKCRZ-15		15	28	28.5
TKCRZ-18		18	28	33
TKCRZ-22		22	34	37
TKCRZ-28		28	38,5	45
TKCRZ-32		32	38	47.5
TKCRZ-35		35	41	49



Skobe za pritrjevanje kablov in cevi, sestavljive, zaprte







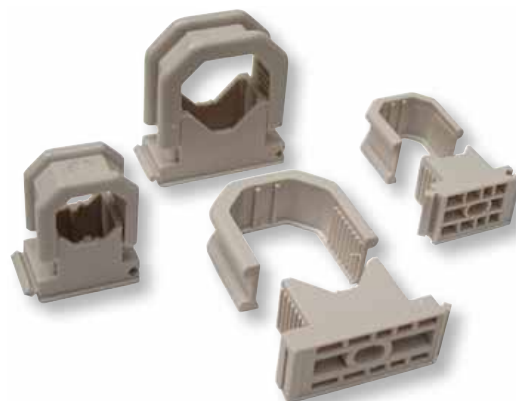
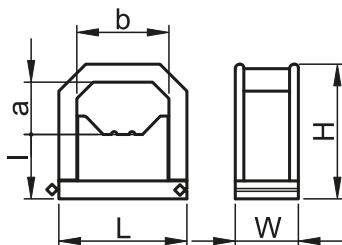

Razlaga piktogramov
C/O

TRACON		a (mm)	b (mm)	L (mm)	l (mm)	H (mm)	W (mm)
BCSV-3		10-18	18.6	26.4	16.2	19.8-37.5	17.7
BCSV-4		19-31	28.8	39.4	15.1	39.5-51.6	18.2



Rebrasti zidni vložki za pritrjevanje kablov





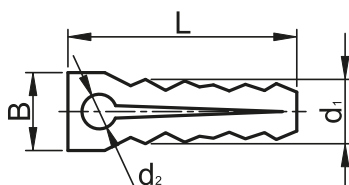

Razlaga piktogramov
C/O

TRACON		d ₁ (mm)	d ₂ (mm)	B (mm)	L (mm)
KRT		6	6	10	36.5
KRT8		8	7.7	12.2	42.7

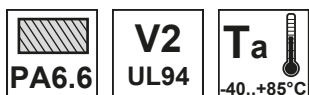

Zidni vložki z robom, s kavljem ali kljuko



TRACON		D × L (mm)	d (mm)	l ₁ (mm)	l ₂ (mm)	B (mm)
T6H		6 × 30	3.3	37	24.2	15.4
T6K		6 × 30	3.3	38.5	10	13.4

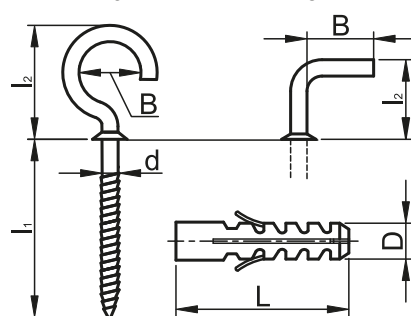

Zidni vložki z robom in vijakom s šestkotno glavo s podložko

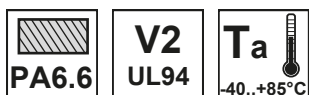

TRACON	D × L (mm)	d × l (mm)
T10080P	10 × 80	6.8 × 95
T10100P	10 × 100	6.8 × 115
T10120P	10 × 120	6.8 × 135
T10140P	10 × 140	6.8 × 155
T10160P	10 × 160	6.8 × 175
T10200P	10 × 200	6.8 × 215
T10240P	10 × 240	6.8 × 255
T10300P	10 × 300	6.8 × 315

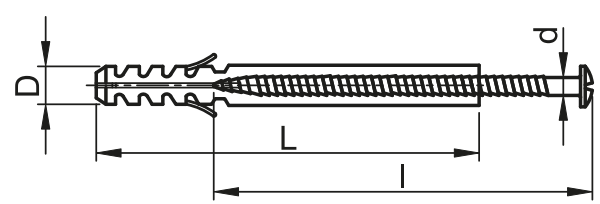

Udarni vložki za mavčne plošče

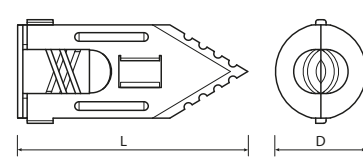

TRACON	D × L (mm)	
GTL30	10,5 × 30	3,5-4 mm
GTL40	10,5 × 40	3,5-4 mm
GTL43	16 × 43	3,5-4 mm



Visoko vzdržljivi zidni vložek iz umetne mase

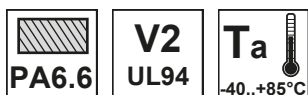

TRACON	D × L (mm)	d × l (mm)*
T5-UNI	5 × 25	3.5 × 35
T6-UNI	6 × 30	4 × 40
T8-UNI	8 × 40	5 × 50
T10-UNI	10 × 50	6 × 60

* Priporočene dimenzije vijaka.

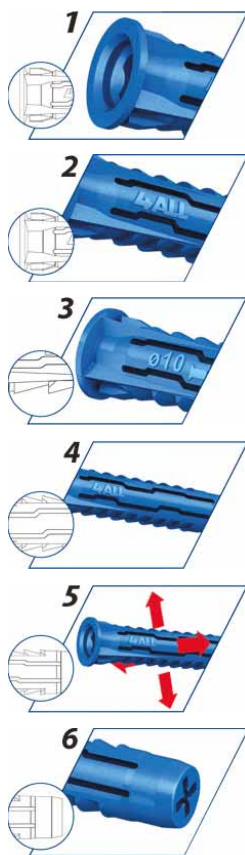
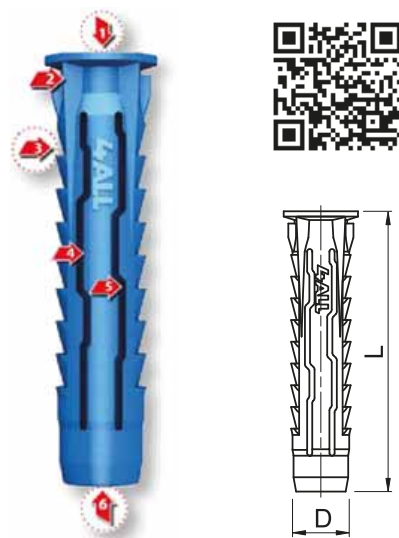

Svojevrsna notranja oblikovanost za zelo dobro prileganje vijaka.

Varovala pred zasukom omogočajo visoko silo oprijema v vseh, tudi v labilnih gradbenih materialih.

Zobje pod glavo povečujejo varno pritrditev ob sočasnem dobrem stiku v vseh materialih.

Razcepni del je tako oblikovan, da se v votlih materialih odpre in s tem odlično zasidra.

4-smerno razpiranje omogoča rabo v vseh materialih in tipih sten.

Ojačana konica zagotavlja ustrezno sidranje med in po montaži.



Beton



Votla opeka



Zidna plošča

Zidni vložki za mavčne plošče

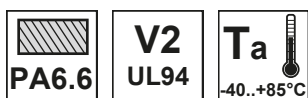

TRACON	Naziv	D × L (mm)	d × l (mm)*
GBT	Vijačni zidni vložek za mavčne plošče	16 × 36	4 × 35
GSZT	Odpiralni zidni vložek za mavčne plošče	10 × 55	4 × 50

* Priporočene dimenzije vijaka.

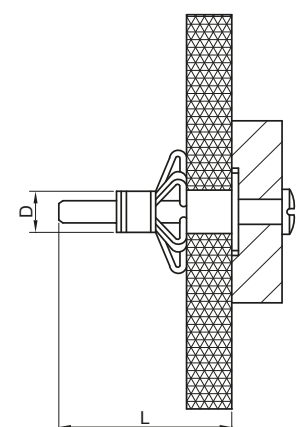

GSZT

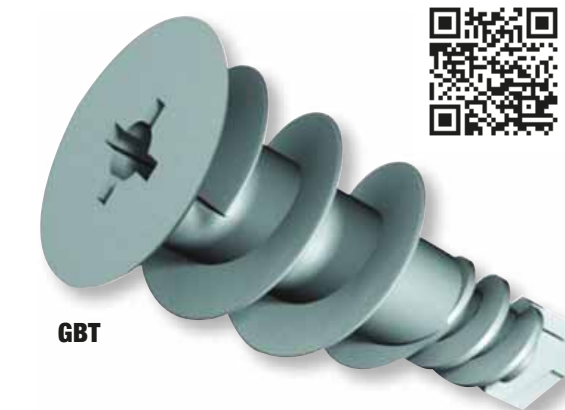

GBT

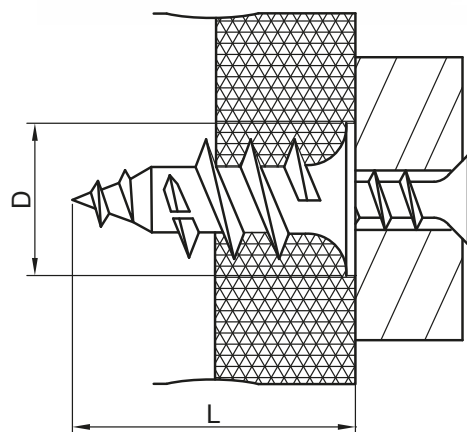

Štirikotni zidni vložki

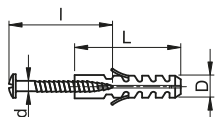
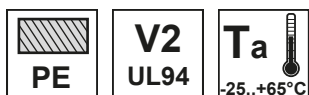

TRACON		D × L (mm)	d × l (mm)
		6 × 23	2.6 × 30
TN6	TNCS6	6 × 23	2.6 × 30
TN8	TNCS8	8 × 34	3.5 × 38
TN10	TNCS10	10 × 42	4.4 × 46
TN12	TNCS12	12 × 52	5.4 × 61
TN14	-	14 × 65	-



Razlaga piktogramov **C/O**

Zabijalni zidni vložki z vijakom

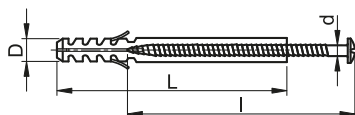
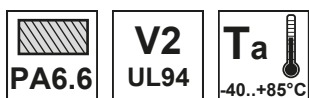

TRACON			TRACON		
	D × L (mm)	d × l (mm)		D × L (mm)	d × l (mm)
TB525	5 × 25	3.5 × 29	TB845	8 × 45	4.9 × 48
TB535	5 × 30	3.5 × 38	TB860	8 × 60	4.4 × 60
TB545	5 × 50	3.5 × 47	TB875	8 × 80	4.7 × 78
TB635	6 × 35	3.7 × 39	TB8100	8 × 100	4.7 × 102
TB645	6 × 40	3.7 × 48	TB8120	8 × 120	4.4 × 122
TB655	6 × 55	3.7 × 58	TB8135	8 × 135	4.4 × 137
TB670	6 × 80	3.2 × 83			



Podaljšani zabijalni zidni vložki z vijakom

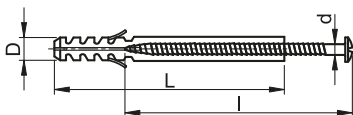
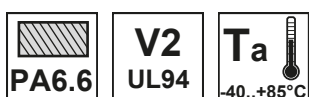

TRACON		D × L (mm)	d × l (mm)
-	THC8100	8 × 100	5.3 × 104
TH8120	THC8120	8 × 120	5.5 × 126
TH8135	THC8135	8 × 135	5.4 × 134
TH1080	THC1080	10 × 80	6.8 × 85
TH10100	THC10100	10 × 100	6.8 × 105
TH10115	THC10115	10 × 115	6.8 × 119
TH10135	THC10135	10 × 135	6.8 × 141
TH10160	THC10160	10 × 160	7 × 165



Standardni zidni vložki

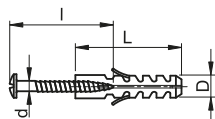
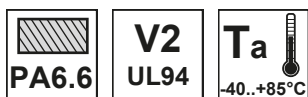

TRACON		D × L (mm)	d × l (mm)
T6-PA	T6CS-PA	6 × 30	4 × 40
T8-PA	T8CS-PA	8 × 40	5 × 50
T10-PA	T10CS-PA	10 × 50	5.5 × 60
T12-PA	-	12 × 60	-
T14-PA	-	14 × 75	-

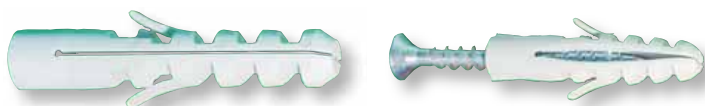

Razlaga piktogramov **C/O**



Zidni vložki z robom

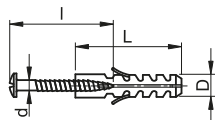
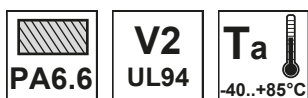

TRACON		D × L (mm)	d × l (mm)
-	T6PCS-PA	6 × 30	4 × 40
T8P-PA	T8PCS-PA	8 × 40	5 × 50
T10P-PA	T10PCSPA	10 × 50	5.5 × 60
T12P-PA	-	12 × 60	-



Samozatezni zidni vložki

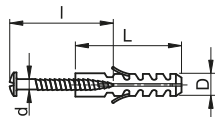
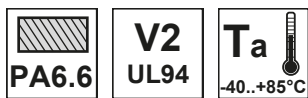

TRACON		D × L (mm)	d × l (mm)
TOP6	TOPCS6	6 × 40	4 × 50
TOP8	TOPCS8	8 × 50	5 × 60
TOP10	TOPCS10	10 × 60	6 × 70



PROSIMO, ODČITAJTE KODO!

- Oglejte si novosti
- Bodite na tekočem

Naša paleta izdelkov se nenehno širi!
Katalog odraža stanje aprila 2021.
Za ažurne informacije obiščite
našo spletno stran!

Stropni vijaki

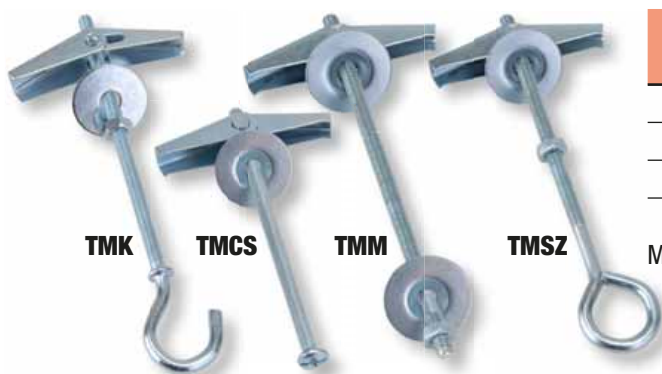

TMK TMCS TMM TMSZ

TRACON	d (mm)	L (mm)	a (mm)	B (mm)	
TMK	M4	95	20	14	200 N
TMCS	M4	81	20	–	800 N
TMM	M4	100	20	–	800 N
TMSZ	M4	93	20	14	200 N

Material: kromirano jeklo

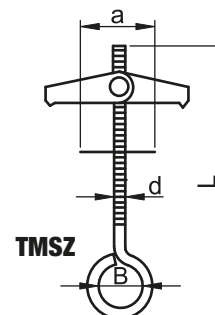
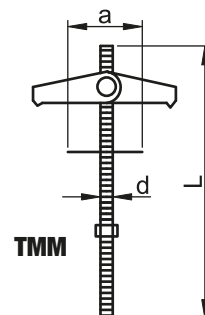
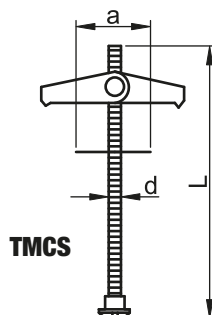
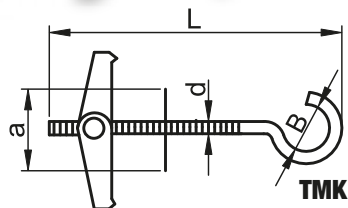

Jekleni vložki za oblikovanje zanke iz jeklene vrvi

TRACON	W (mm)	I (mm)	L (mm)	c (mm)	s (mm)	
SZIV-3	4.5	41.6	46.3	17	1	1 – 3 mm
SZIV-4	5.5	37.7	41.7	15	1	3 – 4 mm
SZIV-5	6.2	37.8	42.4	15	1	4 – 5 mm
SZIV-6	9	42.8	47.5	18.1	1	5 – 6 mm
SZIV-8	9.4	47.7	54.5	19.2	1.5	6 – 7 mm
SZIV-10	12.1	53.8	59.7	21.9	1.5	7 – 9 mm
SZIV-12	17.1	62.4	68.5	28.8	1.5	9 – 12 mm
SZIV-16	21.1	75.7	82.9	39.2	2	12 – 14 mm
SZIV-19	21.6	80.6	90.3	42.2	2.3	16 – 19 mm

Material: jeklo

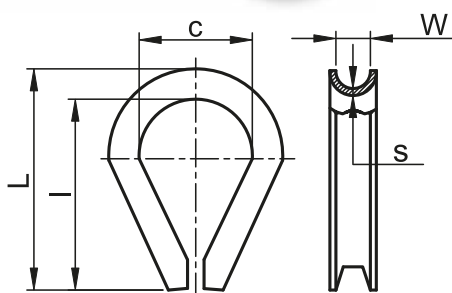

Jekleni kavelj

TRACON	d (mm)	L (mm)	l (mm)	m (mm)	D (mm)	
HR3-25	3	26	20.2	3	7	320 N
HR3-30	3	31.1	25.5	4.8	8.8	320 N
HR4-30	4	33.4	25.5	4.8	10	575 N
HR4-35	4	35.3	27.5	5.2	10.2	575 N
HR4-40	4	41	33.3	5.9	10.9	575 N
HR5-45	4.8	46	36.7	6.6	12.5	730 N
HR5-50	5	53.5	44	10.3	15.3	885 N
HR6-80	6	80	69	12	24	1250 N
HR8-100	8	104	88	17	31	2000 N

Material: jeklo

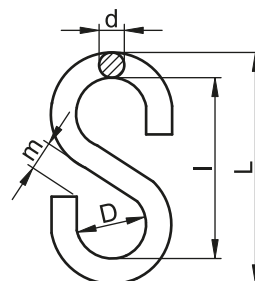

Spojne "U" objemke za jeklene vrvi

TRACON	d (mm)	D (mm)	W (mm)	H (mm)	h (mm)	L (mm)	 mm
U03	M4	5.4	9.5	20.4	7.3	18	2-3 mm
U05	M5	7.2	9.6	24.2	7.5	21.5	3.2-5 mm
U06	M5	8.0	11.2	24.2	9.5	23.8	4.5-7 mm
U08	M6	9	12.9	35.4	10.4	27.4	6.3-8 mm
U09	M8	10.5	16.6	37.3	12.7	33	8-9 mm
U11	M8	11	18.4	41	16	36.4	10-11 mm
U13	M10	14.8	20.6	54.7	18.7	42.2	12-14 mm
U14	M10	14.9	24.2	55.2	23	43.7	12-14 mm
U16	M10	18.2	26	62	25.2	49.9	14-16 mm
U19	M12	21.5	29.7	76.8	30.2	54.4	16-19 mm
U22	M12	21.5	31	77.8	33.2	56.7	19-22 mm
U25	M14	27.7	32.8	95.7	34.5	63.3	22-25 mm

Material: U objemka – jeklo, telo spone – zlitina

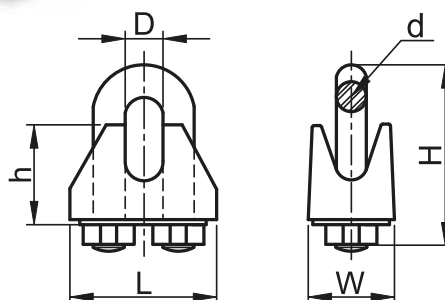

Spone jeklene vrvi, enojne

TRACON	d (mm)	b (mm)	B (mm)	H (mm)	L (mm)	k (mm)
BSZ1-2	M4	5.1	13.6	6.1	17.2	13
BSZ1-3	M4	6.4	15.3	7	18.4	13.6
BSZ1-4	M5	10	16.6	6.5	21	17.4
BSZ1-5	M5	10.4	18.7	8.9	24.4	16.9
BSZ1-6	M6	12.5	23.3	9.6	30.2	21.6
BSZ1-8	M8	18.6	30.4	13.5	36.5	29.2

Material: jeklo

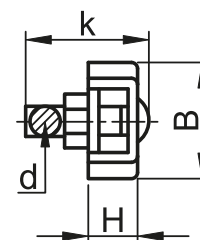
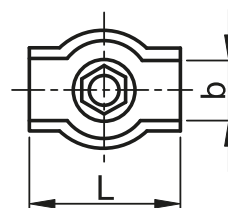

Spone jeklene vrvi, dvojne

TRACON	d (mm)	b (mm)	B (mm)	H (mm)	L (mm)	k (mm)
BSZ2-2	M4	5.8	12.9	5	36.6	13.4
BSZ2-3	M4	6.4	15.3	6.7	35.2	13.5
BSZ2-4	M5	8.4	17.5	7.1	40	17.6
BSZ2-5	M5	11.9	20.4	8.8	48.8	19.6
BSZ2-6	M6	12.5	23.3	9.6	60.5	21.6
BSZ2-8	M8	18.6	30.4	13.5	73	29.2

Material: jeklo

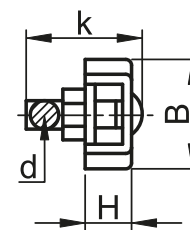
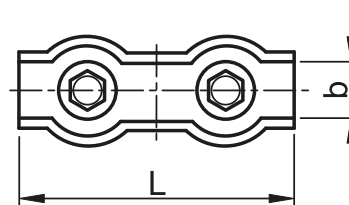

Spone jeklene vrvi

TRACON	d (mm)	W (mm)	H (mm)	L (mm)	k (mm)	
AMAX3	M3	16.1	10.2	28.6	12.7	3 mm (1/8")
AMAX5	M5	17.5	10.7	30.5	12.4	5 mm (3/16")
AMAX6	M6	22.9	12.9	34.9	15.9	6 mm (1/4")

Material: jeklo

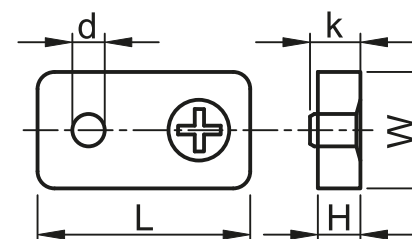

Karabini, vzmetni

TRACON	d (mm)	D (mm)	W (mm)	L (mm)	m (mm)	
RKARA4	4.5	5.8	21.1	42.0	5.5	300 N
RKARA5	5	6.6	26	51.3	7.2	500 N
RKARA6	6	6.9	30.2	62.3	7.7	800 N
RKARA7	7	7.8	35.1	70.7	8.7	1100 N
RKARA8	8	8.1	40.4	80.5	10.2	1400 N
RKARA9	9	9.7	45	90.3	11.7	1700 N
RKARA10	10	11.1	47.3	99.8	13.4	2100 N
RKARA11	11	12.3	57.3	121.2	16.5	2500 N
RKARA12	12	13.9	63.2	142.5	20.8	2700 N
RKARA13	13	15.8	72.8	149.4	24.1	3000 N

Material: jeklo

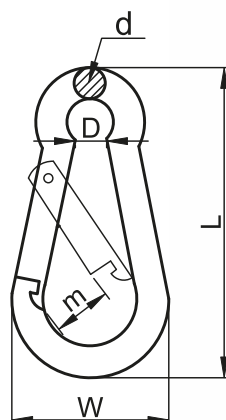

Karabini, vzmetni

TRACON	d (mm)	D (mm)	W (mm)	L (mm)	
CSKARA3,5	3.5	10.8	17.9	35.5	420 N
CSKARA4	4	11.6	19.7	40.6	850 N
CSKARA5	5	13.6	23.5	50.9	1270 N
CSKARA6	6	14.7	26.7	58.3	1700 N
CSKARA7	7	18.4	32	68.2	2550 N
CSKARA8	8	19.6	36	73.8	3100 N
CSKARA9	9	20.6	39.2	82.2	4250 N
CSKARA10	10	21.6	42.4	89.6	5100 N
CSKARA12	12	23.5	48.3	106.2	6400 N

Material: jeklo

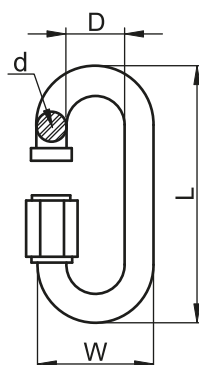

Napenjalci

TRACON			d (mm)	l (mm)	L (mm)	d (mm)	
FSS550	FSH550	FHH550	5	50	92.6	7.8	750 N
FSS570	FSH570	FHH570	5	70	113	8	770 N
FSS660	FSH660	FHH660	6	60	112	10	1050 N
FSS6100	FSH6100	FHH6100	6	100	154	10.2	1800 N
FSS870	FSH870	-	8	70	137	12.3	1200 N
FSS8110	FSH8110	FHH8110	8	110	176	12.3	2000 N
FSS10120	FSH10120	FHH10120	10	120	194	13.3	3000 N
FSS12130	FSH12130	FHH12130	12	130	224	18.3	4450 N
-	FSH16140	FHH16140	16	140	265	22	5950 N

Material: navoj - jeklo, telo - zlitina



FSS



FSH



FHH

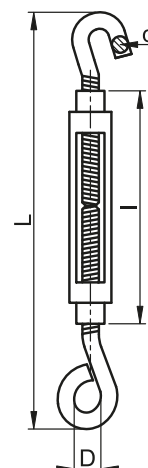

Zaščitne cevi za kable

PP
 V2 UL94
 Ta $-25..+85^{\circ}\text{C}$
 NO Halogen

TRACON	d (mm)	D (mm)	s (mm)		
SPI6	6.2	8.6	1.9	1 m	6 mm
SPI8	8	10.9	2.4	1 m	8 mm
SPI10	10	13.2	2.9	1 m	10 mm
SPI12	12	15.4	2.9	1 m	12 mm
SPI15	15	17.1	2.9	1 m	15 mm
SPI20	20	24	3	1 m	20 mm
SPI25	25	28.7	3	1 m	25 mm

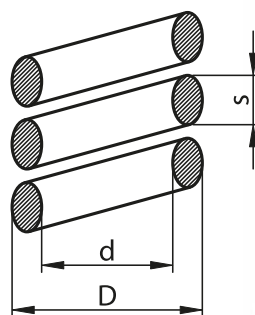

PROSIMO, ODČITAJTE KODO!

- Oglejte si novosti
- Bodite na tekočem

Naša paleta izdelkov se nenehno širi!
 Katalog odraža stanje aprila 2021.
 Za ažurne informacije obiščite
 našo spletno stran!

Spiralni trakovi za povezavo kablov v snope

HB
UL94

TRACON		D (mm)	d (mm)	W (mm)		
KSPI-4N	KSPI-4F	4.5	3.2	6.8	10 m	4...20 mm
KSPI-6N	KSPI-6F	6.9	5.3	10.3	10 m	7...40 mm
KSPI-8N	KSPI-8F	8.4	6.6	11.7	10 m	12...50 mm
KSPI-10N	KSPI-10F	10.2	8.2	13.4	10 m	13...70 mm
KSPI-12N	KSPI-12F	12.2	9.6	15.9	10 m	15...80 mm
KSPI-16N	KSPI-16F	15.7	12.4	21.6	10 m	20...120 mm

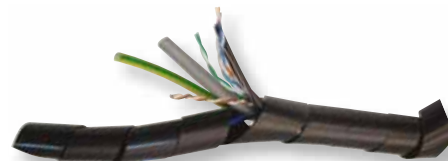
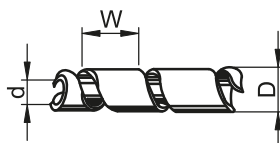

Cevaste kabelske mreže iz umestne mase

V2
UL94

TRACON		
TKH-003	3 mm	2.4 – 6.4 mm
TKH-010	10 mm	4.8 – 15.9 mm
TKH-016	16 mm	9.5 – 25.4 mm
TKH-025	25 mm	15.9 – 36.1 mm
TKH-032	32 mm	19.1 – 44.5 mm



Njena prednost je, da lahko poleg mehanske zaščite, s svojo visoko stopnjo upogljivosti in raztegljivosti odlično spremlja potek kablov in morebitne spremembe presekov. Rez na ustrezno dolžino izvedemo s segretim nožem. Na tak način se rez ne bo zavihal in razparal. Tkanina ne veže nase ne vročine, ne vlage.



Samozapiralna cevasta kabelska mreža

V2
UL94

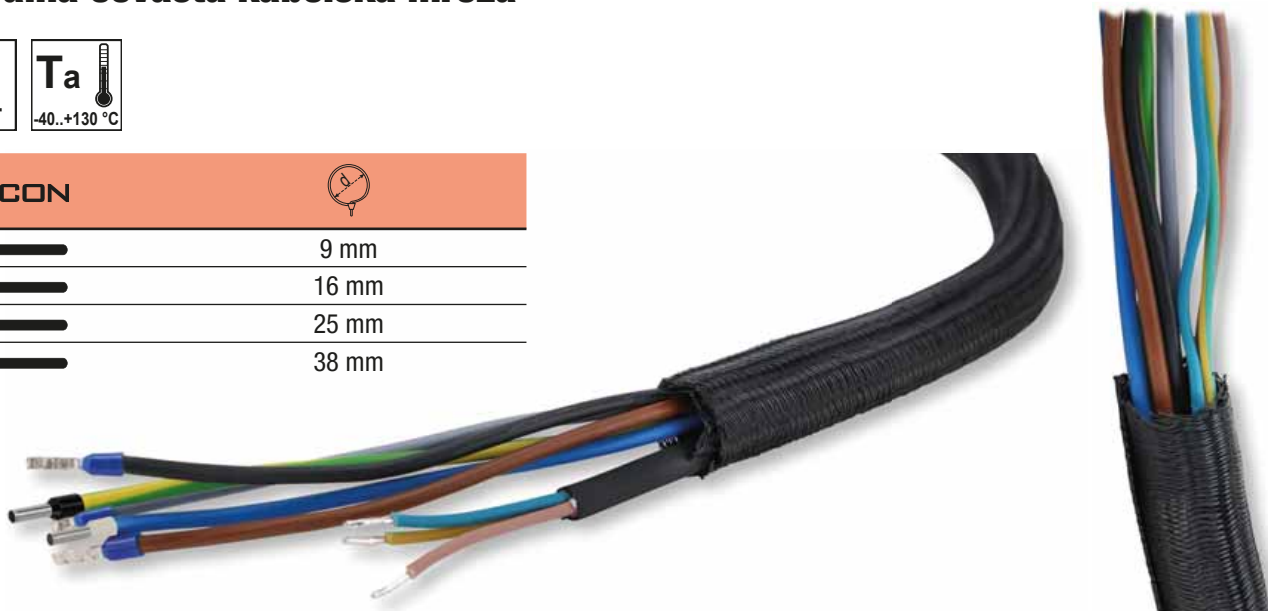
TRACON	
OFK9	9 mm
OFK16	16 mm
OFK25	25 mm
OFK38	38 mm



Označevalne plombe

TRACON		L (mm)	a (mm)	b (mm)	
JPL1		230	18	54	80 N
JPL2		330	18	54	80 N
JPL3		415	21	79	200 N

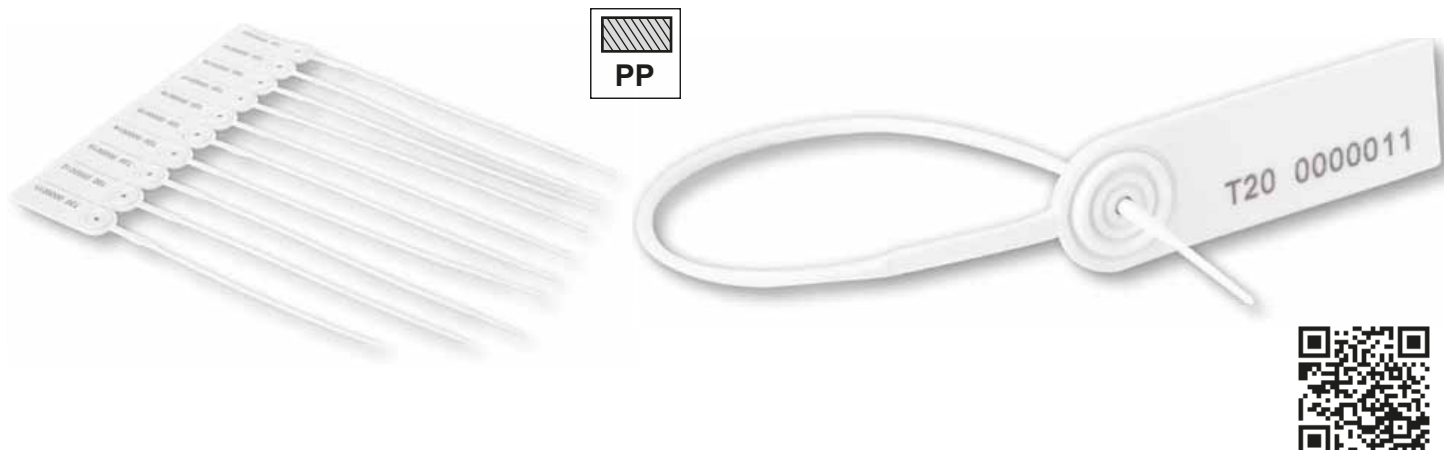

Je sredstvo za označevanje, ki s svojo edinstvenostjo (unikatno serijsko številko) omogoča nadzor nad zaščitenim predmetom. Plombe je zelo enostavno namestiti in odstraniti, za kar ne potrebujete orodja ali pomožnega materiala. Glave naših plastičnih plomb so narejene iz kovine ali trde plastike, zato se na toploti ne zmeščajo in se pri odpiranju zagotovo razcefrajo.



Plombe za števec električen energije

TRACON		a (mm)	b (mm)
MP1		30,5	21
MP2		27	13

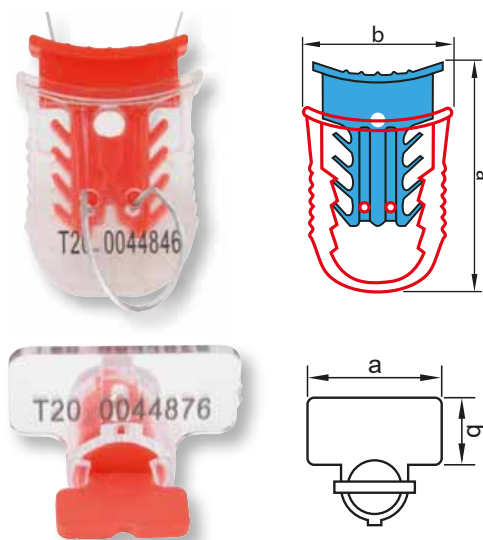

Naše plombe za števec električne energije so primerni za simbolično zaščito razdelilnih omar ter plinskih in drugih števec. Priporočamo jih za vsako mesto, kjer je cilj simbolično zapečatenje, vendar pri tem ne želimo, da bi se pečat predčasno pretrgal. Za namestitev ni potrebno nobeno orodje ali pomožni material.





PROSIMO, ODČITAJTE KODO!

- Oglejte si novosti
- Bodite na tekočem

**Naša paleta izdelkov se nenehno širi!
 Katalog odraža stanje aprila 2021.
 Za ažurne informacije obiščite
 našo spletno stran!**

TRACON
.....ELECTRIC®

EVO

MODULARNA DRUŽINA ARTIKLOV



F/14-F/28